

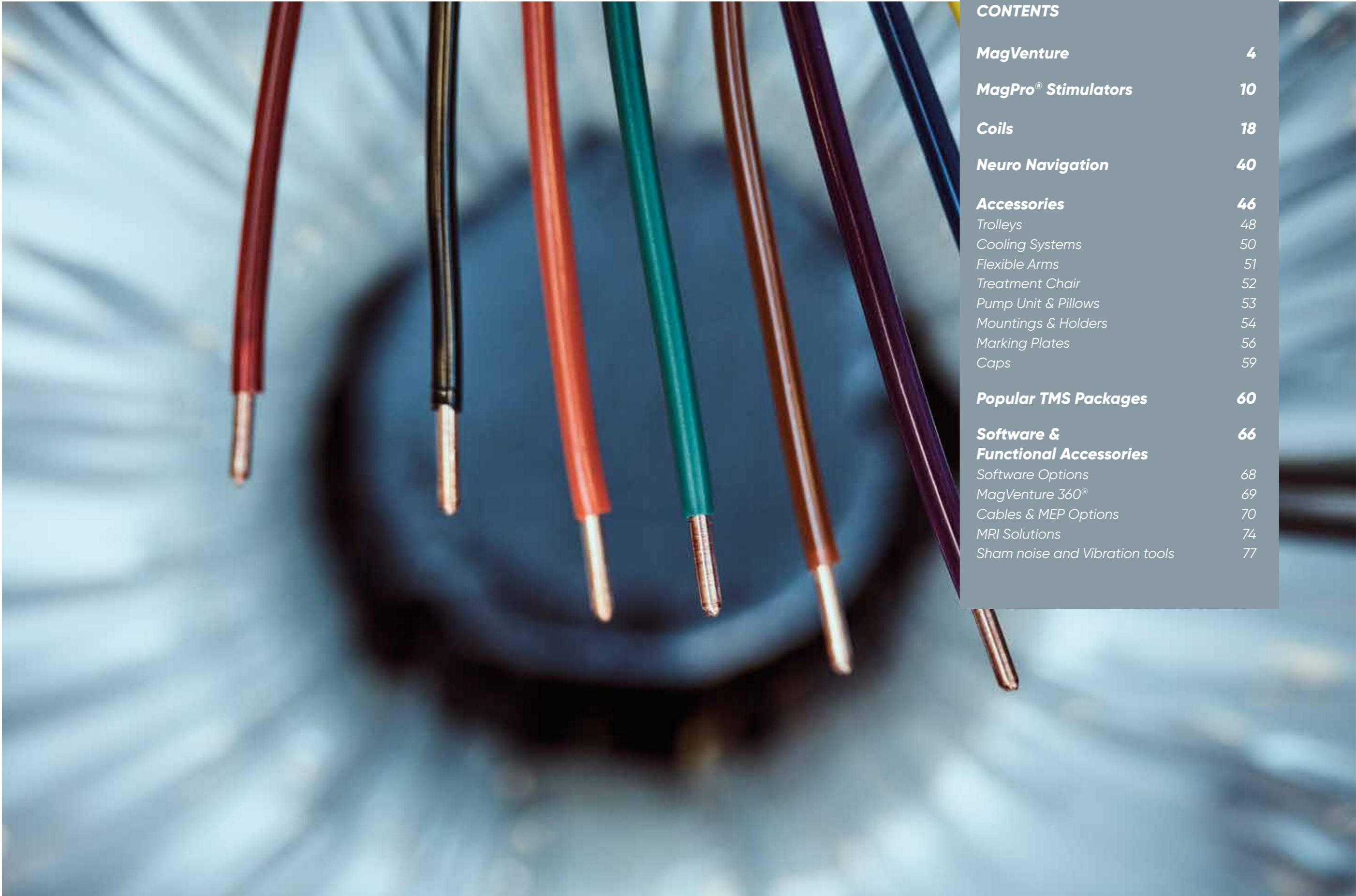

# 2025

## PRODUCT CATALOG

This catalog showcases all products and solutions by MagVenture. Please notice that local license status can vary and not all products may be available in your region.



<b>CONTENTS</b>	
<b>MagVenture</b>	<b>4</b>
<b>MagPro® Stimulators</b>	<b>10</b>
<b>Coils</b>	<b>18</b>
<b>Neuro Navigation</b>	<b>40</b>
<b>Accessories</b>	<b>46</b>
Trolleys	48
Cooling Systems	50
Flexible Arms	51
Treatment Chair	52
Pump Unit & Pillows	53
Mountings & Holders	54
Marking Plates	56
Caps	59
<b>Popular TMS Packages</b>	<b>60</b>
<b>Software &amp; Functional Accessories</b>	<b>66</b>
Software Options	68
MagVenture 360®	69
Cables & MEP Options	70
MRI Solutions	74
Sham noise and Vibration tools	77



**GROUNDED IN RESEARCH,  
 COMMITTED TO TREATMENT,  
 FOCUSED ON RESULTS**

At MagVenture, we're passionate about groundbreaking technology that helps improve people's lives. That's why we've been pioneering non-invasive Transcranial Magnetic Stimulation (TMS) technology for more than 30 years.

Since the earliest days of TMS, we've worked with thousands of researchers to expand their knowledge of the human brain and collaborated with leading neuroscientists to advance technology in psychiatry, neurophysiology, neurology, cognitive neuroscience and rehabilitation.

After many years grounded in the TMS field, we applied our expertise from research and diagnostics to developing clinical TMS and lately Magnetic Peripheral Nerve Stimulation (mPNS) solutions that push the adaptation of clinical applications.

MagVenture is proud to be a privately-owned Danish company. Our products are designed, developed, produced, and quality-tested in Denmark to the highest standards. With subsidiaries in the USA, Brazil, the UK, China, and Germany, as well as a distribution network in more than 60 countries, our reach is truly global.

This catalog showcases our full range\* of products that can provide complete system solutions for your neuromodulation needs. With our range of flexible, modular products, you can configure the TMS system that meets your specific requirements, and you can add accessories and even upgrade your system as your needs change.

We're here to support you in choosing the TMS system and accessories that best suit your needs, so please speak to us about how we can help.

\* Some products may not be available in your region due to licensing approvals and regulations. Please consult your local MagVenture representative for guidance.

**VISION**

*To offer new hope to patients by transforming how mental health and physical conditions are treated*

**MISSION**

*To pioneer safe, effective, and reliable magnetic stimulation therapies, offer innovative and versatile research solutions and work to expand access to magnetic stimulation worldwide*

## MORE THAN 30 YEARS OF TMS INNOVATION

From the first MagPro stimulator for brain stimulation research to supplying a wide range of devices for use in the treatment of psychiatric disorders, MagVenture has been a pioneer in TMS technology for more than 30 years.

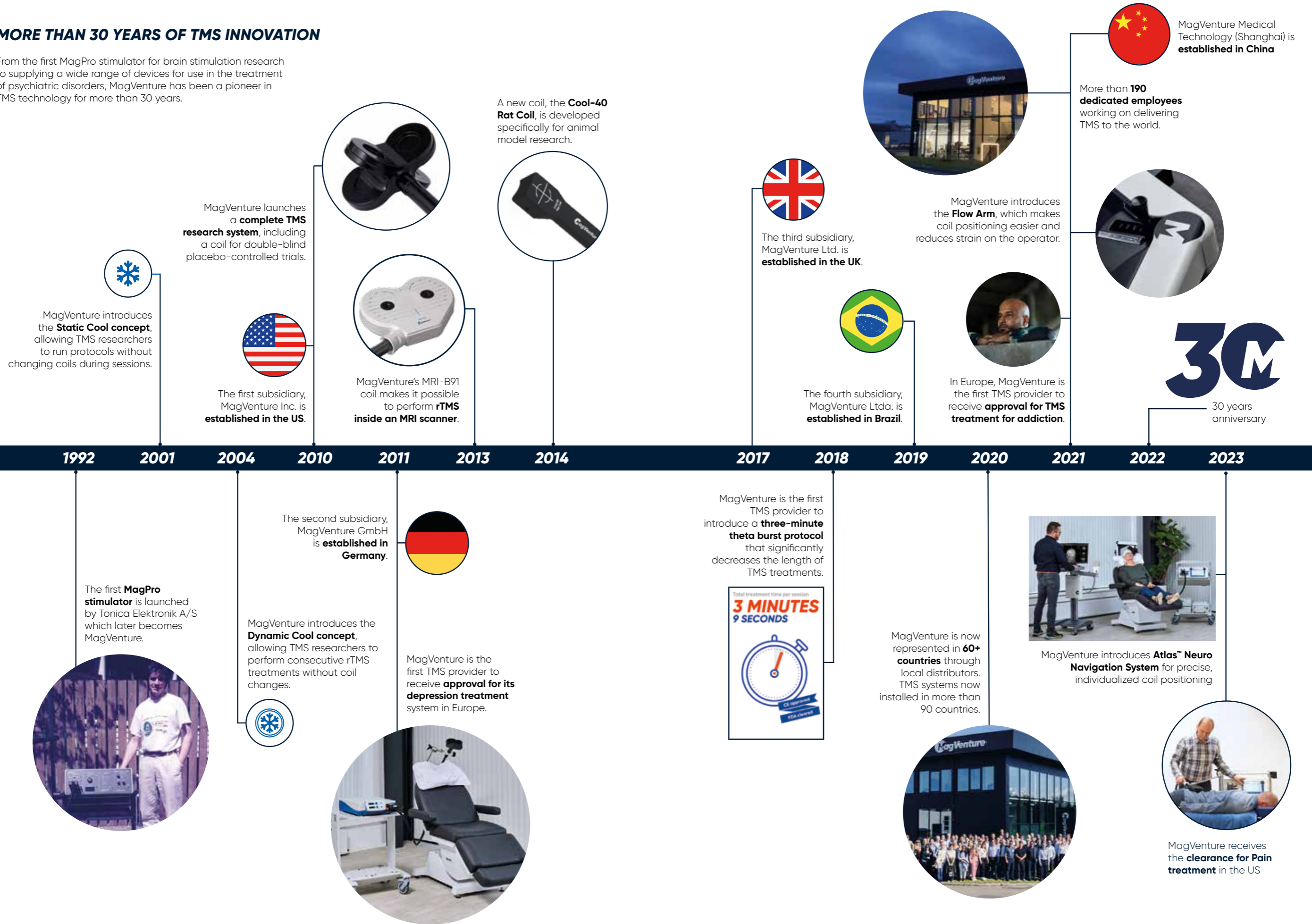



# MAGVENTURE SUBSIDIARIES AND DISTRIBUTORS WORLDWIDE

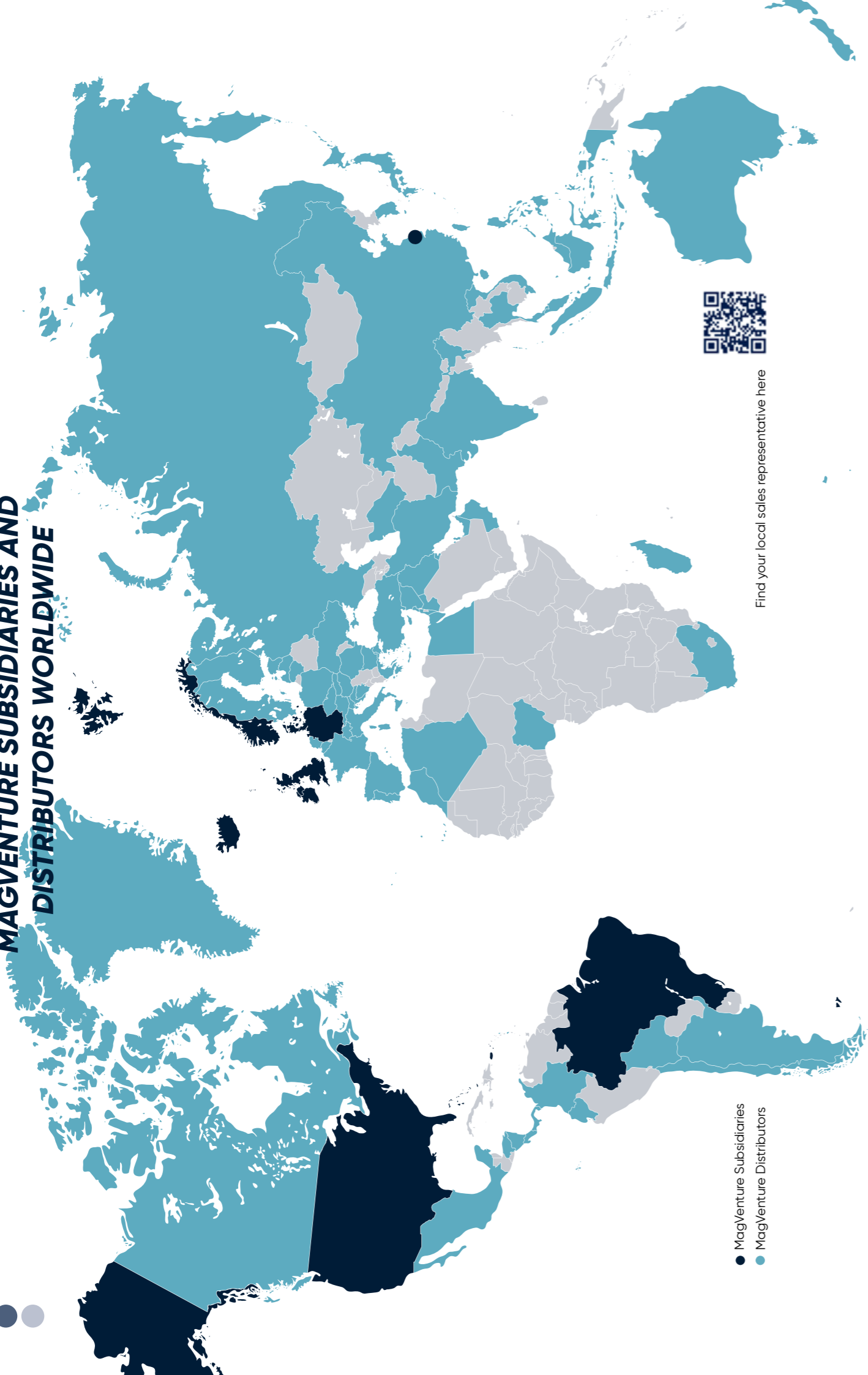

- MagVenture Subsidiaries
- MagVenture Distributors

Find your local sales representative here





## MAGPRO® STIMULATORS

With nine different stimulators to choose from, our high-performing TMS solutions meet a wide range of requirements for use in research, diagnostics, and treatment. Features include defined protocols, storage and retrieval of protocols, automatic sequence set-up, transferrable data, advanced in/out triggers for EEG, EMG, and EP equipment. Designed to ease your workflow and ensure accuracy and consistency in all TMS processes.





### MagPro Compact

The MagPro Compact is intended as an electro-physiological aid to assess and monitor the central and peripheral nervous systems, based on the use of motor evoked potential (MEP). It is designed to be used in combination with electromyographic (EMG) equipment. The power control and trigger button are integrated into the coil handle making it simple and effective to operate.



Part no.	Max repetition rate	Pulse mode	Waveform	Current direction	Ramp up
9016E0852	5 pps	Standard	Biphasic	Normal	No

### MagPro R20

The MagPro R20 is a magnetic stimulator intended as an electro-physiological aid to assess and monitor the central and peripheral nervous systems. A diagnostic tool to measure motor evoked potential (MEP) in clinical examinations and for therapeutic use. It can be applied for treatment with standard 10 Hz or 15 Hz protocols. The device is compatible with a wider range of coils than the MagPro Compact and is ideal for clinics running a limited number of TMS sessions per day. Quick and easy to set up.



Part no.	Max repetition rate	Pulse mode	Waveform	Current direction	Ramp up
9016E0861	20 pps	Standard	Biphasic	Normal	No

### MagPro R20+

The MagPro R20+ is a high-performance compact magnetic stimulator intended for therapeutic purposes. It can be used as a diagnostic tool to measure motor evoked potential (MEP) in clinical examinations and for therapeutic use with standard 10 Hz or 15 Hz protocols. Because of its increased energy efficiency due to shorter pulse widths, MagPro R20+ can run more TMS sessions per day than the MagPro R20 and is able to stimulate at higher frequency rates – up to 100 Hz.



Part no.	Max repetition rate	Pulse mode	Waveform	Current direction	Ramp up
9016E0881	100 pps	Standard	Biphasic	Normal	No

### MagPro R20+ Express

It is possible to add a theta burst solution and a wifi package to the MagPro R20+ stimulator, called the MagPro R20+ Express. The MagPro R20+ Express includes a Wi-Fi package and theta burst capabilities. The Wi-Fi package enables protocol set-up via a computer. This system can run 3-minute therapy, currently the fastest TMS therapy available, known as "theta burst" or Express TMS.



\* The MagPro R20 cannot be upgraded with Theta Burst functionality.

Part no.	Max repetition rate	Pulse mode	Waveform	Current direction	Ramp up
9016E0911	100 pps	Standard	Biphasic Biphasic Burst (Theta Burst)	Normal	No

### MagPro R30

The MagPro R30 is a high-performance TMS magnetic stimulator primarily for clinical use as well as research. A diagnostic tool to measure motor evoked potential (MEP) and for therapeutic treatment. It performs repetitive transcranial magnetic stimulation and can run many complex protocols successively; up to 20,000 pulses in one session. The theta burst option can be added to run theta burst stimulation; 60 pps and 80 pps options can also be added. Allows for storage of multiple stimulator setups, external control, and heat tolerance when performing intense, focused, and repeated protocols.



Part no.	Max repetition rate	Pulse mode	Waveform	Current direction	Ramp up
9016E0721	30 pps, 60 pps, 80 pps	Standard	Biphasic, Biphasic Burst (Theta Burst)	Normal	Yes

### MagPro R30 inclusive MagOption

The MagPro R30 with MagOption can provide both biphasic and monophasic pulse waveforms, paired-pulses or twin-pulses, complex pulse firing patterns, and high frequency stimulation up to 30 Hz. With the same features as the MagPro R30 but with enhanced stimulation capabilities, it provides monophasic waveform and twin and dual pulses up to 5 pps (both monophasic and biphasic). Allows for storage of multiple stimulator setups, external control, and heat tolerance when performing intense, focused, and repeated protocols. It has the same features as the R30 with additional advanced diagnostic capabilities.



Part no.	Max repetition rate	Pulse mode	Waveform	Current direction	Ramp up
9016E0741	30 pps	Standard, Dual, Twin	Biphasic, Monophasic	Normal	Yes

### MagPro X100

The MagPro X100 is a high performance magnetic stimulator designed primarily for research. It can provide both biphasic and monophasic pulse waveforms, electronically reverse current direction, complex pulse firing patterns, and high frequency stimulation up to 100 Hz. The device allows for storage of multiple stimulator setups, external control, and heat tolerance when performing intense, focused, and repeated protocols. Supports all clinical protocols, research, and diagnostic usage.



Part no.	Max repetition rate	Pulse mode	Waveform	Current direction	Ramp up
9016E0711	100 pps 250 pps	Standard	Biphasic, Monophasic, Biphasic Burst (Theta Burst)	Normal, Reverse	Yes

### MagPro X100 inclusive MagOption

A high performance magnetic stimulator primarily for research. The MagPro X100 with MagOption offers a wide range of stimulation parameters, theta burst and stimulation rates up to 100 Hz, and the possibility to combine waveforms and pulse modes. With the same features as the MagPro X100, it also provides half-sine waveforms, twin and dual pulses up to 50 pps (biphasic) and has a power mode with a 40% increase in intensity and pulse width.



Part no.	Max repetition rate	Pulse mode	Waveform	Current direction	Ramp up
9016E0731	100 pps 250 pps	Standard, Dual, Twin, Power	Biphasic, Monophasic, Biphasic Burst (Theta Burst), Half-sine	Normal, Reverse	Yes

### Isolation Transformer

MagVenture's isolation transformer for MagPro R20, R20+, R30 and X100 devices. The Isolation Transformer reduces leakage current and is able to distribute power for stimulators and auxiliary devices such as the coil cooler unit, treatment chair and vacuum pump.



100 V	120 V	200 V	230 V
Part no. 9016D0051	Part no. 9016D0031	Part no. 9016D0071	Part no. 9016D0041

### MagPro XP Orange Edition

The MagPro XP Orange Edition has the same single pulse power as the R30 and X100 but is able to maintain high frequency, high intensity stimulation without power decline and can deliver up to 250 Hz. The first stimulator to bridge the gap between electrophysiological memory models and TMS, using the same frequency as the human brain. With fully integrated, cooling, it can run the most demanding, focused stimulations without coil overheating. It comes as a fully encased, integrated system with a practical console design that makes it easy to transport. Optimized for interleaved TMS/fMRI research.

The MagPro XP Orange Edition is a research tool only, developed for advanced brain research. It does require a special license.





300 us, 100 V	300 us, 120 V	300 us, 230 V
Part no. 9016A0501	Part no. 9016A0511	Part no. 9016A0521
200 us, 100 V	200 us, 120 V	200 us, 230 V
Part no. 9016A0701	Part no. 9016A0711	Part no. 9016A0721

Max repetition rate	Pulse mode	Waveform	Current direction	Ramp up
250 pps	Standard	Biphasic, Biphasic Burst (Theta Burst)	Normal	No



## STIMULATOR OVERVIEW

								
MagPro Model		XP Orange	X100 MO	X100	R30 MO	R30	R20 Family	Compact
Maximum Repetition Rate	250 pps	•	• <sup>6</sup>	• <sup>6</sup>				
	100 pps		•	•			• <sup>4</sup>	
	80 pps					• <sup>1</sup>		
	60 pps					• <sup>2</sup>		
	30 pps				•	•		
	20 pps						•	
	5 pps							•
Pulse Mode	Power Mode		•					
	Dual/Twin		•		•			
Waveform	Standard	•	•	•	•	•	•	•
	Biphasic	•	•	•	•	•	•	•
	Theta Burst (Biphasic Burst)	•	•	•		• <sup>3</sup>	• <sup>5</sup>	
	Monophasic		•	•	•			
	Half-Sine		•					
Current Direction	Normal and Reverse		•	•				
Sham Noise	(Add-on)	•	•	•	•	•		

 MRI compatible

 Can be used with the MagVenture double-blind research software

 Translational research compatible

- 1 With 80 pps option
- 2 With 60 pps option
- 3 With TBS option
- 4 R20+ or MagPro R20+ Express
- 5 MagPro R20+ Express
- 6 With 250 pps option





## COILS

With more than 40 coils to choose from, our diverse coil selection is designed to suit your intended use in TMS research, diagnostics, and treatment. Our coils come in a range of shapes and sizes for different purposes, with features such as cooling, power control and triggering on the handle. For low intensity protocols with limited stimuli, our standard coils without cooling are the best choice. For more intensive protocols with a higher number of stimuli, we have different types of cooling – static, active and high-performing, to suit the required number of pulses for your intended purpose.

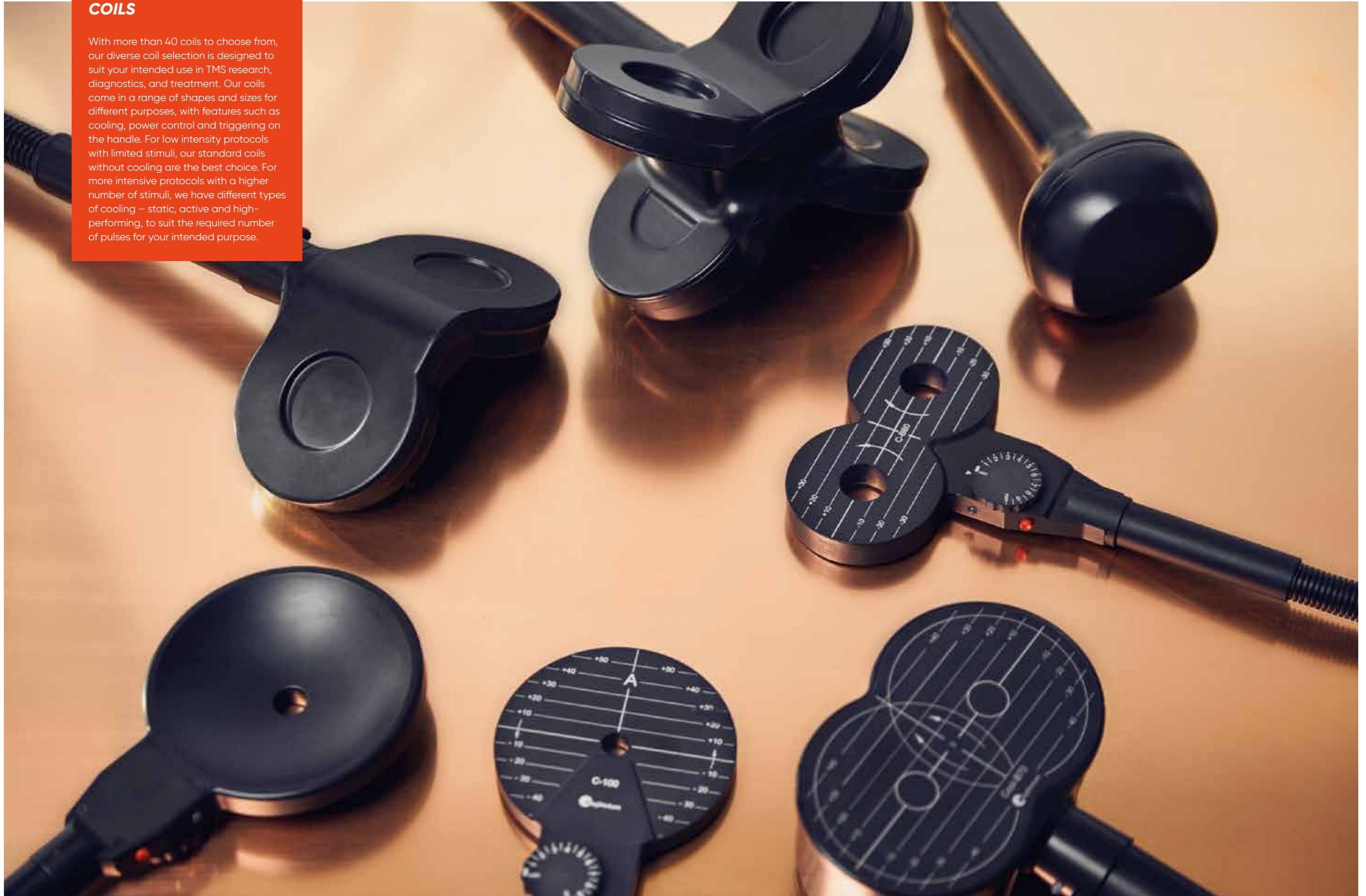



## COIL FAMILY

**Active cooling:** A coil with dynamic cooling liquid pumped between the coil and an ambient room temperature heat exchange system (cooler). Allowing intensive treatment sessions to be performed successively.

**Static cooling:**

A coil with a static heat sink, allowing treatment to be performed without over-heating of the coil.

**TMS-Robot/Cobot (RO/CO):** A coil designed especially to be moved by an Axilum Robot. The first generation is referred to as "Robot", the second generation is referred to as "Cobot".

**Active/Placebo (A/P):** A double-sided coil with an active side and an inactive (placebo) side, which look exactly the same. The internal orientation switch and research mode on the stimulator allows for double-blind studies in which both the operator and the subject are unaware of treatment modality.

**Placebo (P):** An inactive coil with the same sound as the active coil. Allows for single-blind studies.

Coil shape	No cooling	❄️ Static cooling (MCF-series)	❄️ Active cooling (Cool-series)
Circular	-	<b>MCF-75</b>	-
	<b>C-100</b> Intensity wheel	-	-
	<b>MC-125</b>	<b>MCF-125</b>	<b>Cool-125</b>
		<b>MCF-140</b>	-
Parabolic	<b>MMC-90</b>	-	-
	<b>MMC-140</b> <b>MMC-140-II</b> Intensity wheel	-	-
	<b>MMC-140 A/P</b>	-	-
Butterfly (Figure of 8)	<b>MC-B35</b>	-	<b>Cool-B35</b> <b>Cool-B35 RO</b> <b>Cool-B35 HO</b> Orthogonal
	<b>C-B60</b> Intensity wheel <b>MC-B65-HO</b> Orthogonal	<b>MCF-B65</b> <b>MCF-P-B65</b>	<b>Cool-B65</b> <b>Cool-B65 A/P</b> <b>Cool-B65 RO</b> <b>Cool-B65 CO</b> <b>Cool-B65 A/P RO</b> <b>Cool-B65 A/P CO</b>
	<b>C-B70</b> Intensity wheel <b>MC-P-B70</b>	<b>MCF-B70</b> <b>MCF-P-B70</b>	<b>Cool-B70</b> <b>Cool-B70 A/P</b>
	<b>MC-B70</b>		<b>Cool-B70 CO</b>
	<b>D-B80</b> <b>D-B110</b>	-	<b>Cool D-B80</b> <b>Cool D-B80 A/P</b>
	<b>MRI-B91</b>	-	<b>MRI-B91 Air Cooled</b>
	<b>RT-120</b> <b>RT-120-II</b> Intensity wheel	-	-
Elliptical (Racetrack)			
D-shape	-	-	<b>Cool-D50</b>
Rat Coil	-	-	<b>Cool-40</b> (Rat Coil)





### C-100

A circular coil, without cooling, suitable for diagnostic use. Equipped with power control and a trigger button for ease of operation.



Part no.	Shape	Cooling	Placebo
9016E0582	Circular	No cooling	No

<b>Outer diameter</b>	ø123 mm / 4.84 in.
<b>Penetration depth (70 V/m)</b>	39.6 mm / 1.56 in.
<b>Magnetic field</b>	Gradient at 20 mm: 21 kT/s

### MC-125

A circular coil, without cooling, suitable for diagnostic use. Equipped with power control and a trigger button for ease of operation.

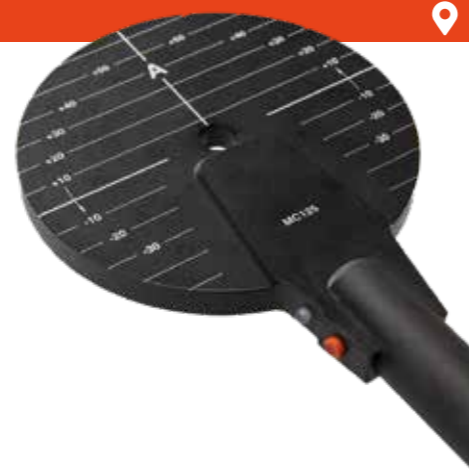

Part no.	Shape	Cooling	Placebo
9016E0555	Circular	No cooling	No

<b>Outer diameter</b>	ø130 mm / 5.12 in.
<b>Penetration depth (70 V/m)</b>	38.5 mm / 1.52 in.
<b>Magnetic field</b>	Gradient at 20 mm: 18 kT/s

### MMC-90

A parabolic-shaped coil, without cooling, focused and compact stimulation. Suitable for stimulation of selected neuromuscular units based on its size and shape. Equipped with a trigger button on the handle for ease of operation.



Part no.	Shape	Cooling	Placebo
9016E0211	Parabolic	No cooling	No

<b>Outer diameter</b>	ø95 x 22 mm / 3.74 x 0.87 in.
<b>Angle</b>	Concave
<b>Penetration depth (70 V/m)</b>	34 mm / 1.34 in.
<b>Magnetic field</b>	Gradient at 20 mm: Concave side 24 kT/s. Convex side 14 kT/s

### MMC-140

A parabolic-shaped coil, without cooling, for broad and deep stimulation. The concave and convex shape gives flexibility in the placement of coil during stimulation. Equipped with a trigger button on the handle for ease of operation.



Part no.	Shape	Cooling	Placebo
9016E0573	Parabolic	No cooling	No

<b>Outer diameter</b>	ø143 x 14.5mm / 5.63 x 0.57 in.
<b>Angle</b>	Concave
<b>Penetration depth (70 V/m)</b>	43.4 mm / 1.70 in.
<b>Magnetic field</b>	Gradient at 20 mm: 21 kT/s

### MMC-140-II

A parabolic-shaped coil, without cooling, for broad and deep stimulation. The concave and convex shape gives flexibility in the placement of coil during stimulation. Equipped with power control and a trigger button on the handle for ease of operation. The coil can handle more stimulation before overheating than the MMC-140 version.



Part no.	Shape	Cooling	Placebo
9016E0631	Parabolic	No cooling	No

<b>Outer diameter</b>	ø143 x 17 mm / 5.63 x 0.67 in
<b>Angle</b>	Concave
<b>Penetration depth (70 V/m)</b>	44.3 mm / 1.74 in.
<b>Magnetic field</b>	Gradient at 20 mm: 20 kT/s

### MMC-140 A/P

A parabolic-shaped active/placebo coil, without cooling, for advanced clinical studies with double-blind experiments. With identical electrical and magnetic properties to the MMC-140-II, it functions as both an active (A) and placebo (P) coil. The symmetrical design gives no indication of which is the active side and which is the placebo side.



Part no.	Shape	Cooling	Placebo
9016E0251	Parabolic	No cooling	Yes

<b>Outer diameter</b>	ø145 mm / 5.7 in
<b>Angle</b>	Concave
<b>Penetration depth (70 V/m)</b>	44.3 mm / 1.74 in. (Active side)
<b>Magnetic field (active side)</b>	Gradient at 20 mm: 9 kT/s

Note: An active/placebo coil with active magnetic stimulation on one side and no magnetic stimulation on the other side.



**MCF-140**

A large, circular coil designed to deliver broad and deep stimulation. The MCF-140 features static cooling, enabling it to support stimulation protocols requiring a high number of stimuli without the need for external cooling. It also includes a convenient trigger button on the handle for ease of use.



Part no.	Shape	Cooling	Placebo
9016E0021	Circular	Static cooling	No

**Outer diameter** 169 mm / 6.65 in.

**Magnetic field** Gradient at 20 mm: 20kT/s

**MCF-75**

A circular coil with static cooling that provides very high field strength near the skin, optimal for peripheral stimulation. Designed for demanding stimulation protocols that require a higher number of stimuli without external cooling. Equipped with a trigger button on the handle for ease of operation.



Part no.	Shape	Cooling	Placebo
9016E0442	Circular	Static cooling	No

**Outer diameter** ø88 mm / 3.50 in.

**Penetration depth (70 V/m)** 26.7 mm / 1.05 in.

**Magnetic field** Gradient at 20 mm: 15 kT/s

**MCF-125**

A large circular coil providing broad and deep stimulation. The MCF-125 has static cooling and is designed for stimulation protocols, that require higher number of stimuli without the need for external cooling. Equipped with a trigger button on the handle for ease of operation.



Part no.	Shape	Cooling	Placebo
9016E0413	Circular	Static cooling	No

**Outer diameter** ø140 mm / 5.51 in.

**Penetration depth (70 V/m)** 39.2 mm / 1.54 in.

**Magnetic field** Gradient at 20 mm: 16 kT/s

**Cool-125**

A large circular coil, with active cooling that provides broad and deep stimulation. The Cool-125 coil has the same electrical and magnetic properties as the MCF-125, designed for protocols that require a very high number of stimuli. Equipped with a trigger button on the handle for ease of operation.



Part no.	Shape	Cooling	Placebo
9016E0511	Circular	Active cooling	No

**Outer diameter** ø140 mm / 5.51 in.

**Penetration depth (70 V/m)** 37.7 mm / 1.48 in.

**Magnetic field** Gradient at 20 mm: 16 kT/s

**Cool-40 (Rat Coil)**

A circular coil, with active cooling, designed for studying the effects of TMS in rodents. For animal studies only. Not for human use. The Cool-40 (Rat Coil) can be used in PET or SPECT imaging scanners. The coil size fits in bore size down to ø12 cm in diameter. Requires a high-performance cooling system.



Part no.	Shape	Cooling	Placebo
9016E0241	Circular	Active cooling	No

**Outer dimensions** 52 x 54 mm / 2 x 2.1 in.

**Penetration depth (70 V/m)** 10.2 mm / 0.4 in.

**Magnetic field** Gradient at 20 mm: 9 kT/s

Note: Not for human use.

**MC-B35**

A butterfly-shaped coil, without cooling, for focused stimulation of small areas of the brain, peripheral nerves and muscles. The MC-B35 has a compact design with the handle placed orthogonal to the coil surface. Equipped with a trigger button on the handle for ease of operation. Can also be used with the MagPro Compact stimulator with converter. Because of its size, the MC-B35 coil allow for a multi-channel set-up in clinical research.



Part no.	Shape	Cooling	Placebo
9016E0671	Butterfly	No cooling	No

**Outer dimensions** 103 x 55 mm / 4.05 x 2.16 in.

**Penetration depth (70 V/m)** 27.5 mm / 1.08 in.

**Magnetic field** Gradient at 20 mm: 10 kT/s



### C-B60

A butterfly-shaped coil, without cooling, for focused stimulations. Equipped with power control and a trigger button on the handle for ease of operation. To use for motor threshold determination, combine with treatment coils Cool-B65 and MCF-B65.



Part no.	Shape	Cooling	Placebo
9016E0482	Butterfly	No cooling	No

**Outer dimensions** 165 x 85 mm / 6.5 x 3.35 in.

**Penetration depth (70 V/m)** 31.5 mm / 1.24 in.

**Magnetic field** Gradient at 20 mm: 9 kT/s

### D-B80

A double-cone coil, without cooling. The D-B80 is specifically designed to reach deeper cortical structures, the coil is concave at a 120° angle to suit the shape of the head. Equipped with a trigger button on the handle for ease of operation.



Part no.	Shape	Cooling	Placebo
9016E0431	Butterfly	No cooling	No

**Outer dimensions** 196 x 106 mm / 7.7 x 4.17 in.

**Angle** 120°

**Penetration depth (70 V/m)** 42.7 mm / 1.68 in.

**Magnetic field** Gradient at 20 mm: 12 kT/s

### D-B110

The D-B110 is a double-cone coil without cooling, specifically designed for targeting deeper cortical structures. Its concave design, angled at 120°, is shaped to fit the contours of the head. The coil is equipped with a trigger button on the handle for convenient operation.



Part no.	Shape	Cooling	Placebo
9016E0011	Concave	No cooling	No

**Outer dimensions** 126 mm / 4.96 in.

**Magnetic field** Gradient at 20mm: 11kT/s

### MC-B65-HO-2

A butterfly-shaped coil with 2-meter cable length, without cooling. The coil handle is placed orthogonal to the coil housing.



Part no.	Shape	Cooling	Placebo
9016E0462	Butterfly	No cooling	No

**Outer dimensions** 165 x 85 mm / 6.5 x 3.35 in.

**Penetration depth (70 V/m)** 32.7 mm / 1.29 in.

**Magnetic field** Gradient at 20 mm: 9 kT/s

### MC-B65-HO-8

A butterfly-shaped coil with 8-meter cable length, without cooling. The coil handle is placed orthogonal to the coil housing.



Part no.	Shape	Cooling	Placebo
9016E0472	Butterfly	No cooling	No

**Outer dimensions** 165 x 85 mm / 6.5 x 3.35 in.

**Penetration depth (70 V/m)** 32.7 mm / 1.29 in.

**Magnetic field** Gradient at 20 mm: 9 kT/s

### MC-B70

A butterfly-shaped coil, without cooling, for focused stimulation. The MC-B70 coil is slightly concave to suit the shape of the head. The special design results in a low a motor threshold level. Equipped with a trigger button on the handle for ease of operation.

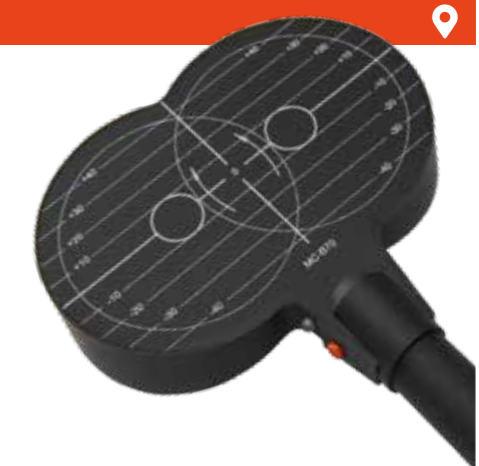

Part no.	Shape	Cooling	Placebo
9016E0564	Butterfly	No cooling	No

**Outer dimensions** 169 x 112 mm / 6.65 x 4.40 in.

**Angle** 150°

**Penetration depth (70 V/m)** 37.3 mm / 1.47 in.

**Magnetic field** Gradient at 20 mm: 15 kT/s



### MC-P-B70

A placebo coil for single-blind studies with a mechanical outline and sound level identical to MC-B70. The MC-P-B70 coil's magnetic shield reduces the magnetic field by approximately 80%. The coil has a slightly concave surface to suit the shape of the head.

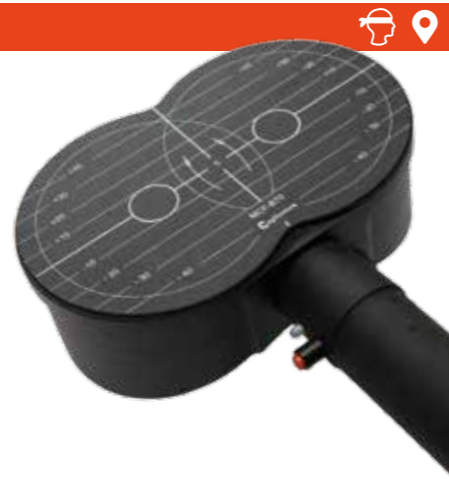

Part no.	Shape	Cooling	Placebo
9016E0592	Butterfly	No cooling	Yes

**Outer dimensions** 169 x 112 mm / 6.7 x 4.4 in.

**Angle** 150°

Note: This is a placebo coil with no active magnetic stimulation.

### C-B70

A butterfly-shaped coil, without cooling, suitable for focused stimulations. Equipped with power control and a trigger button on the handle for ease of operation. The specific configuration of C-B70 allows for motor mapping even in difficult cases. The C-B70 coil has the same magnetic field strength as the Cool-B70 coil when used with an appropriate marking plate.



Part no.	Shape	Cooling	Placebo
9016E0141	Butterfly	No cooling	No

**Outer dimensions** 170 x 113 mm / 6.69 x 4.45 in.

**Angle** 150°

**Penetration depth (70 V/m)** 37.3 mm / 1.47 in.

**Magnetic field** Gradient at 20 mm: 15 kT/s

### MCF-B65

A butterfly-shaped coil, with static cooling, designed for protocols that require a high number of stimuli without external cooling. Equipped with a trigger button on the handle for ease of operation.



Part no.	Shape	Cooling	Placebo
9016E0423	Butterfly	Static cooling	No

**Outer dimensions** 172 x 92 mm / 6.9 x 3.7 in.

**Penetration depth (70 V/m)** 31.5 mm / 1.24 in.

**Magnetic field** Gradient at 20 mm: 9 kT/s

### MCF-P-B65

A butterfly shaped placebo coil with static cooling. The MCF-P-B65 coil has a mechanical outline, sound level, and available stimuli identical to MCF-B65. The coil's magnetic shield reduces the magnetic field by approximately 80%. Equipped with a trigger button on the handle for ease of operation.



Part no.	Shape	Cooling	Placebo
9016E0601	Butterfly	Static cooling	Yes

**Outer dimensions** 174 x 94 mm / 6.8 x 3.7 in.

Note: This is a placebo coil with no active magnetic stimulation.

### MCF-B70

A butterfly-shaped coil, with static cooling, for highly focused protocols that require higher number of stimuli without external cooling. Equipped with a trigger button on the handle for ease of operation. Designed with a slightly concave surface for best contact with the skull and reduced motor threshold level.



Part no.	Shape	Cooling	Placebo
9016E0401	Butterfly	Static cooling	No

**Outer dimensions** 180 x 116 mm / 7.1 x 4.6 in.

**Angle** 150°

**Penetration depth (70 V/m)** 34.0 mm / 1.34 in.

**Magnetic field** Gradient at 20 mm: 12 kT/s

### MCF-P-B70

A butterfly shaped placebo coil with static cooling. The MCF-P-B70 coil has a mechanical outline, sound level, and available stimuli identical to MCF-B70. Butterfly-shaped, with static cooling. The coil's magnetic shield reduces the magnetic field by approximately 80%. Equipped with a trigger button on the handle for ease of operation.

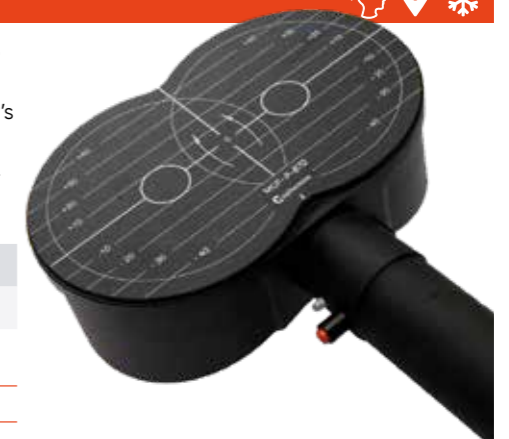

Part no.	Shape	Cooling	Placebo
9016E0201	Butterfly	Static cooling	Yes

**Outer dimensions** 180 x 116 x 45 mm

**Angle** 150°

Note: This is a placebo coil with no active magnetic stimulation.



### Cool-B35

A butterfly-shaped coil, with active cooling, suitable for focused stimulation, with similar properties to the MC-B35. It has a large ergonomic handle. Equipped with a trigger button on the handle for ease of operation.

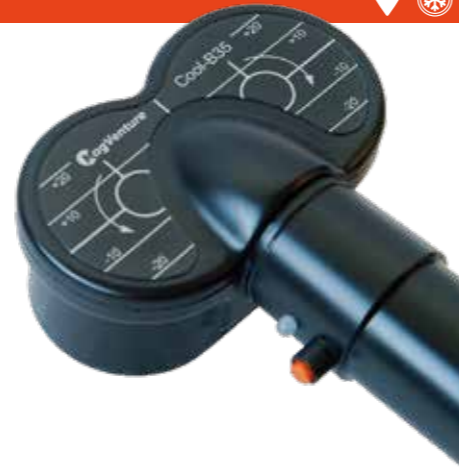

Part no.	Shape	Cooling	Placebo
9016E0681	Butterfly	Active cooling	No

**Outer dimensions** 113 x 65 mm / 4.4 x 2.6 in.

**Penetration depth (70 V/m)** 23.1 mm / 0.9 in.

**Magnetic field** Gradient at 20 mm: 7 kT/s

### Cool-B35 RO

A butterfly-shaped coil, with active cooling. Specifically designed for use in an Axilum robot system solution. The Cool-B35 RO is based on the standard Cool-B35 coil but has a longer cable and no trigger switch or LED in the handle.



Part no.	Shape	Cooling	Placebo
9016E0101	Butterfly	Active cooling	No

**Outer dimensions** 113 x 65 mm / 4.4 x 2.6 in.

**Penetration depth (70 V/m)** 23.1 mm / 0.9 in.

**Magnetic field** Gradient at 20 mm: 7 kT/s

### Cool-B35 HO

A butterfly-shaped coil, with active cooling, suitable for focused stimulation, with similar properties as the MC-B35. It has a compact design with an orthogonal coil handle. Equipped with a trigger button on the handle for ease of operation.



Part no.	Shape	Cooling	Placebo
9016E0111	Butterfly	Active cooling	No

**Outer dimensions** 113 x 65 mm / 4.4 x 2.6 in.

**Penetration depth (70 V/m)** 23.1 mm / 0.9 in.

**Magnetic field** Gradient at 20 mm: 7 kT/s

### Cool-B65

A butterfly-shaped coil, with active cooling, for focused stimulation, designed for protocols that require a very high number of stimuli. Optimized for high repetition rates and long pulse trains. Cooled by an external Cooler Unit. Equipped with a trigger button on the handle for ease of operation.

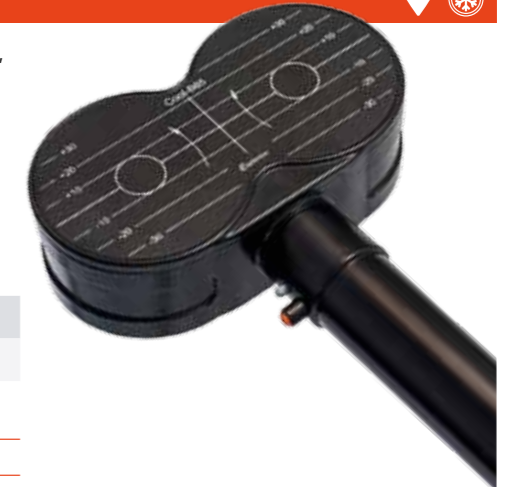

Part no.	Shape	Cooling	Placebo
9016E0491	Butterfly	Active cooling	No

**Outer dimensions** 172 x 92 mm / 6.8 x 3.6 in.

**Penetration depth (70 V/m)** 31.5 mm / 1.24 in.

**Magnetic field** Gradient at 20 mm: 9 kT/s

### Cool-B65 RO

The Cool-B65 RO coil is designed specifically for use with an Axilum Robotics Robot system solution. The coil has the same properties as the standard Cool-B65 coil - butterfly-shaped, with active cooling, for focused stimulation and demanding protocols that require a very high number of stimuli. Optimized for high repetition rates and long pulse trains. Cooled by an external Cooler Unit. The RO version has a longer cable.



Part no.	Shape	Cooling	Placebo
9016E0221	Butterfly	Active cooling	No

**Outer dimensions** 172 x 92 mm / 6.8 x 3.6 in.

**Penetration depth (70 V/m)** 31.5 mm / 1.24 in.

**Magnetic field** Gradient at 20 mm: 9 kT/s

### Cool-B65 CO

The Cool-B65 CO coil is designed specifically for use with an Axilum Robotics Cobot system solution. The coil has the same properties as the standard Cool-B65 coil - butterfly-shaped, with active cooling, for focused stimulation and demanding protocols that require a very high number of stimuli. Optimized for high repetition rates and long pulse trains. Cooled by an external Cooler Unit. The CO version does not have a trigger switch or LED in the handle.



Part no.	Shape	Cooling	Placebo
9016E0151	Butterfly	Active cooling	No

**Outer dimensions** 172 x 92 mm / 6.8 x 3.6 in.

**Penetration depth (70 V/m)** 31.5 mm / 1.24 in.

**Magnetic field** Gradient at 20 mm: 9 kT/s



### Cool-B65 A/P

A butterfly-shaped active/placebo coil, with active cooling, for clinical studies with double-blind experiments. The symmetrical design gives no indication of which is the active side and which is the placebo side. An adjustable output for current stimulation of the patient's skin synchronously with magnetic stimulation pulses is built in.



Part no.	Shape	Cooling	Placebo
9016E0501	Butterfly	Active cooling	Yes

<b>Outer dimensions</b>	172 x 92 mm / 6.8 x 3.6 in.
<b>Penetration depth (70 V/m)</b>	31.5 mm / 1.24 in. (active side)
<b>Magnetic field (active side)</b>	Gradient at 20 mm: 9 kT/s

Note: This is an active/placebo coil with active magnetic stimulation on one side and no magnetic stimulation on the other side.

### Cool-B65 A/P RO

An active/placebo coil with the same properties as the Cool-B65 A/P, designed for use in an Axilum Robotics Robot system solution. The RO version has a longer cable and does not have a trigger switch or LED in the handle.

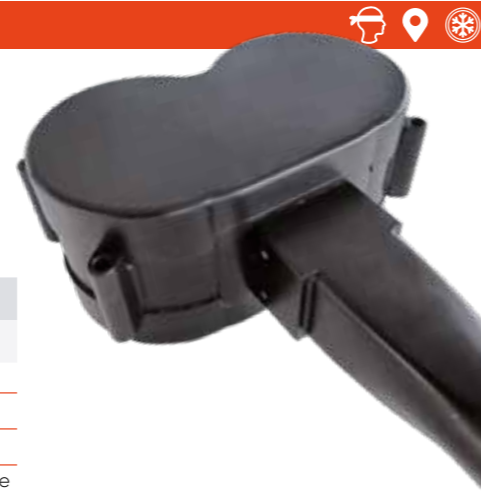

Part no.	Shape	Cooling	Placebo
9016E0231	Butterfly	Active cooling	Yes

<b>Outer dimensions</b>	172 x 92 mm / 6.8 x 3.6 in.
<b>Penetration depth (70 V/m)</b>	31.5 mm / 1.24 in. (active side)
<b>Magnetic field (active side)</b>	Gradient at 20 mm: 9 kT/s

Note: This is an active/placebo coil with active magnetic stimulation on one side and no magnetic stimulation on the other side.

### Cool-B65 A/P CO

An active/placebo coil with the same properties as the Cool-B65 A/P, designed for use in Axilum Robotics Cobot system solution. The RO version does not have a trigger switch or LED in handle. Only for use with double-blind research studies with MagPro R30/X100 (with or without MagOption).

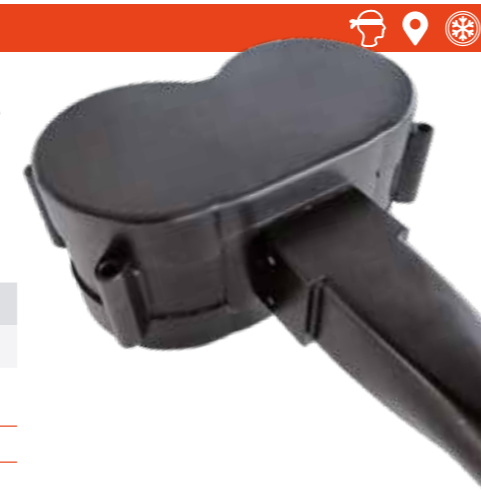

Part no.	Shape	Cooling	Placebo
9016E0161	Butterfly	Active cooling	Yes

<b>Outer dimensions</b>	172 x 92 mm / 6.8 x 3.6 in.
<b>Penetration depth (70 V/m)</b>	31.5 mm / 1.24 in. (active side)
<b>Magnetic field (active side)</b>	Gradient at 20 mm: 9 kT/s

Note: This is an active/placebo coil with active magnetic stimulation on one side and no magnetic stimulation on the other side.

### Cool D-B80

A double-cone coil, with active cooling, for powerful stimulation. The Cool-D-B80 has the same electrical and magnetic properties as the D-B80. Specifically designed to reach deeper cortical structures, the coil is concave at a 120° angle to suit the shape of the head. Equipped with a trigger button on the handle for ease of operation.



Part no.	Shape	Cooling	Placebo
9016E0531	Butterfly	Active cooling	No

<b>Outer dimensions</b>	2 x ø110 mm / 2 x ø4.33 in.
<b>Angle</b>	120°
<b>Penetration depth (70 V/m)</b>	41.8 mm / 1.65 in.
<b>Magnetic field</b>	Gradient at 20 mm: 11 kT/s

### Cool D-B80 A/P

A double-cone active/placebo coil, with active cooling, for advanced clinical studies with double-blind experiments. With identical electrical and magnetic properties to the D-B80 and the Cool D-B80 coils. The symmetrical design gives no indication of which is the active side and which is the placebo side.

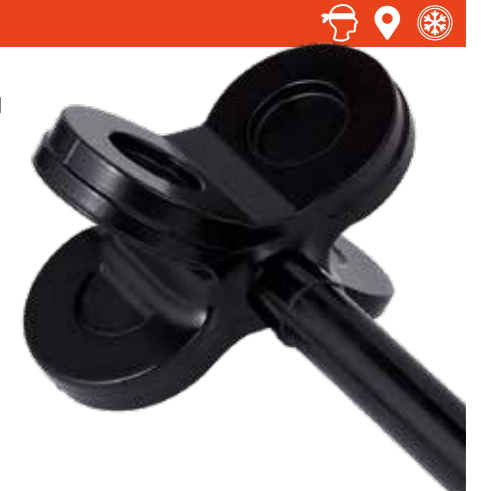

Part no.	Shape	Cooling	Placebo
9016E0541	Butterfly	Active cooling	Yes

<b>Outer dimensions</b>	220 x 115 mm / 8.7 x 4.5 in.
<b>Angle</b>	120°
<b>Penetration depth (70 V/m)</b>	41.8 mm / 1.65 in. (active side)
<b>Magnetic field (active side)</b>	Gradient at 20 mm: 12 kT/s

Note: This is an active/placebo coil with active magnetic stimulation on one side and no magnetic stimulation on the other side.

### Cool-B70

A butterfly-shaped coil, with active cooling, suitable for focused stimulations and demanding protocols that require a very high number of stimuli. The Cool-B70 coil has electrical and magnetic properties comparable with the MCF-B70. Designed with a slightly concave surface for best possible contact with the skull. Equipped with a trigger button on the handle for ease of operation.



Part no.	Shape	Cooling	Placebo
9016E0521	Butterfly	Active cooling	No

<b>Outer dimensions</b>	180 x 116 mm / 7.1 x 4.6 in.
<b>Penetration depth (70 V/m)</b>	34.0 mm / 1.34 in.
<b>Magnetic field</b>	Gradient at 20 mm: 12 kT/s

### Cool-B70 A/P

A butterfly-shaped active/placebo coil, with active cooling, for advanced clinical studies with double-blind experiments. With comparable electrical and magnetic properties to the MCF-B70 and Cool-B70 coils. The symmetrical design gives no indication of which is the active side and which is the placebo side.



Part no.	Shape	Cooling	Placebo
9016E0121	Butterfly	Active cooling	Yes

**Outer dimensions** 173 x 116 mm / 6.8 x 4.6 in.

**Angle** 150°

**Penetration depth (70 V/m)** 34.0 mm / 1.34 in. (active side)

**Magnetic field (active side)** Gradient at 20 mm: 12 kT/s

Note: This is an active/placebo coil with active magnetic stimulation on one side and no magnetic stimulation on the other side.

### Cool-B70 CO

The Cool-B70 CO coil is specifically designed for integration with the Axilum Robotics Cobot system. Retaining the properties of the standard Cool-B70 coil, it features a butterfly shape and active cooling, making it ideal for focused stimulation and demanding protocols requiring a high number of stimuli. It is optimized for high repetition rates and extended pulse trains, with cooling provided by an external Cooler Unit. This coil is equipped with a trigger switch and a LED in the handle.



Part no.	Shape	Cooling	Placebo
9016E0181	Butterfly	Active cooling	No

**Outer dimensions** 180x116 mm/7.1x4.6 in.

**Penetration depth (70 V/m)** 34.0 mm / 1.34 in.

**Magnetic field (active side)** Gradient at 20 mm: 12 kT/s

### MRI-B91

A butterfly-shaped coil, without cooling, designed for use in MRI scanners up to 4 Tesla. The MRI-B91 coil is suitable for focused stimulation. The special design allows for frequent stimulation inside the scanner without too many coil vibrations, reducing noise exposure. A built in counter shows remaining pulses/days.



Part no.	Shape	Cooling	Placebo
9016E0661	Butterfly	No cooling	No

**Outer dimensions** 175 x 142 x 30 mm / 6.89 x 5.59 x 1.18 in.

**Penetration depth (70 V/m)** 31.5 mm / 1.22 in.

**Magnetic field** Gradient at 20 mm: 8 kT/s

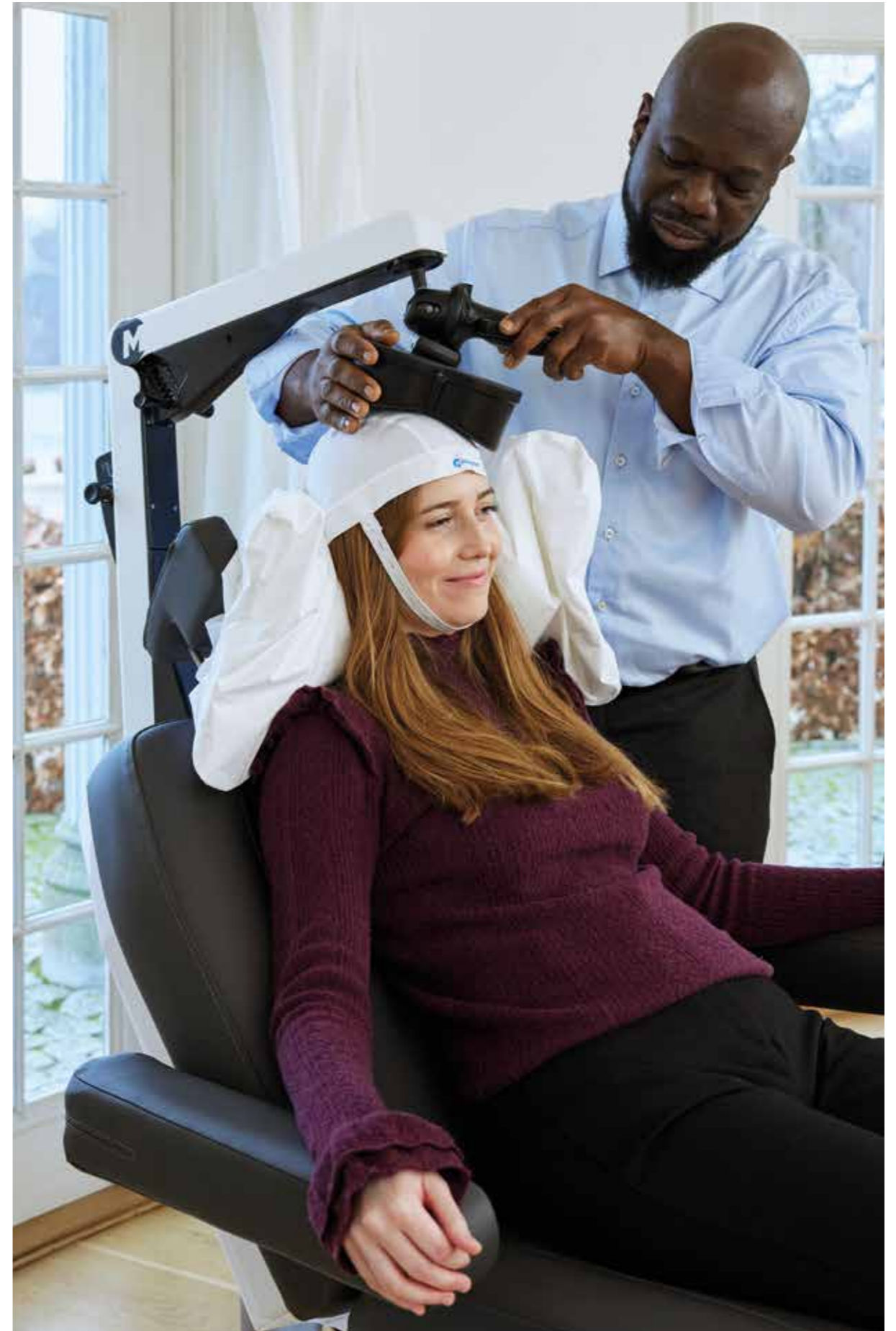



### MRI-B91 Air Cooled

A butterfly-shaped coil, with compressed air-cooling, designed to run longer and tougher protocols inside MRI scanners up to 4 Tesla. The MRI-B91 Air Cooled coil is suitable for focused stimulation. The special design allows for low vibration stimulation and reduced noise exposure. A built in counter shows remaining pulses/days.



Part no.	Shape	Cooling	Placebo
9016E0271	Butterfly	Active cooling	No

**Outer dimensions** 175 x 142 x 30 mm / 6.89 x 5.59 x 1.18 in.

**Penetration depth (70 V/m)** 31.1 mm / 1.22 in.

**Magnetic field** Gradient at 20 mm: 8 kT/s

### Ever thought about what lies beneath the surface of a magnetic coil?



"For illustrative purposes only".

### RT-120

An elliptical coil, without cooling, especially suited for stimulation of wider areas such as large muscles, with the coil placement aligned to the direction of the handle direction. Equipped with a trigger button for ease of operation.



Part no.	Shape	Cooling	Placebo
9016E0641	Elliptic	No cooling	No

**Outer diameter** ø90 x 175 x 26 mm / 3.54 x 6.89 x 1.02 in.

**Penetration depth (70 V/m)** 35.2 mm

**Magnetic field** Gradient at 20 mm: 15 kT/s

### RT-120-II

An elliptical coil, without cooling, especially suited for stimulation of wider areas such as large muscles, spinal areas, with the coil placement parallel to direction of the handle direction. Equipped with power control and a trigger button for ease of operation.



Part no.	Shape	Cooling	Placebo
9016E0651	Elliptic	No cooling	No

**Outer diameter** ø90 x 200 x 26 mm / 3.54 x 7.87 x 1.02 in.

**Penetration depth (70 V/m)** 35.2 mm

**Magnetic field** Gradient at 20 mm: 15 kT/s

### Cool-D50

A research coil with D-shaped windings to produce an asymmetric field, with active cooling. The stimulation center is placed at the edge of the coil allowing for simultaneous stimulation of two centers in the brain only 2-3 cm apart using two Cool-D50 coils individually activated.



Part no.	Shape	Cooling	Placebo
9016E0291	D-shape	Active cooling	No

**Outer dimensions** 111 x 94 mm / 4.4 x 3.7 in.

**Penetration depth (70 V/m)** 30.7 mm / 1.21 in.

**Magnetic field** Gradient at 20 mm: 16 kT/s

ELLIPTICAL AND D-SHAPED

## COIL OVERVIEW

### Circular Coils

A "general purpose" coil which can be positioned over many parts of the body to stimulate a fairly large area.

Model	Shape	Cooling	Diameter of handle (øD in mm)
C-100 <sup>1</sup>	Circular	No cooling	ø29
MC-125	Circular	No cooling	ø29
MMC-90	Circular (Parabolic)	No cooling	ø29
MMC-140 MMC-140 II <sup>1</sup>	Circular (Parabolic)	No cooling	ø29
MCF-75	Circular	Static cooling	ø25
MCF-125	Circular	Static cooling	ø29
Cool-125	Circular	Active cooling	ø38
MCF-140	Circular	Static cooling	ø29
Cool-40 Rat Coil	Circular	Active cooling	

### Butterfly Coils

The butterfly coil is useful in focused stimulation. The two windings are placed side-by-side which enables the coil to stimulate structures with focus right under its center.

Model	Shape	Cooling	Diameter of handle (øD in mm)
MC-B35	Butterfly	No cooling	ø25
C-B60 <sup>1</sup>	Butterfly	No cooling	ø29
C-B70 <sup>1</sup>	Butterfly	No cooling	ø29
D-B80	Butterfly	No cooling	ø29
MC-B65 HO	HO Butterfly	No cooling	ø25
Cool D-B110	Butterfly	Active cooling	ø38
MC-B70	Butterfly	No cooling	ø29
MCF-B65	Butterfly	Static cooling	ø29
MCF-B70	Butterfly	Static cooling	ø38
Cool-B35 Cool-B35 RO Cool-B35 HO	Butterfly	Active cooling	ø38
Cool-B65 Cool-B65 RO Cool-B65 CO	Butterfly	Active cooling	ø38
Cool D-B80	Butterfly	Active cooling	ø38
Cool-B70	Butterfly	Active cooling	ø38
Cool-B70 CO	Butterfly	Static cooling	ø38
MRI-B91	Butterfly	No cooling	
MRI-B91 Air Cooled	Butterfly	Forced air	

### Elliptical (Racetrack) and D-shaped Coils

Elliptical (Racetrack) coils are especially suitable for stimulation of wider areas. Use two D-shaped coils to simultaneously stimulate two centers in the brain only 2-3 cm / 1 inch apart.

Model	Shape	Cooling	Diameter of handle (øD in mm)
RT-120	Racetrack	No cooling	ø25
RT-120 II <sup>1</sup>	Racetrack	No cooling	ø25
Cool-D50	D-shaped	Active cooling	ø38

### Placebo Coils

Coils specifically developed for placebo studies. Some are for true double-blind research studies with both an active and a placebo side.

Model	Shape	Cooling	Diameter of handle (øD in mm)
MC-P-B70	Butterfly (Placebo)	No cooling	ø29
MCF-P-B65	Butterfly (Placebo)	Static cooling	ø29
Cool-B65 A/P Cool-B65 A/P RO Cool-B65 A/P CO	Butterfly (Active/Placebo)	Active cooling	ø38
Cool-B70 A/P	Butterfly (Active/Placebo)	Active cooling	ø38
Cool D-B80 A/P	Butterfly (Active/Placebo)	Active cooling	ø38
MMC-140 A/P	Circular (Parabolic, Active/Placebo)	No cooling	ø29
MCF-P-B70	Butterfly (Placebo)	Static cooling	ø38

### Temperature performance

Standard coils:

MCF coils:

Cool coils:

Cool coils incl. high performance cooler: 

<sup>1</sup> With built-in power control.



## NEURO NAVIGATION

### What is neuro navigation?

Neuro navigation systems enable image-guided navigation to help locate specific areas of the brain for guiding a TMS coil in real time within the confines of the skull or vertebral column while providing live, visual feedback. When neuro navigation devices are incorporated into TMS therapy, it is sometimes referred to as nTMS.

MagVenture offers two distinct neuro navigation platforms based on either electro magnetic or optical tracking giving customers the flexibility to choose the right system for their individual needs. Both systems utilize the most advanced navigation hardware from NDI.

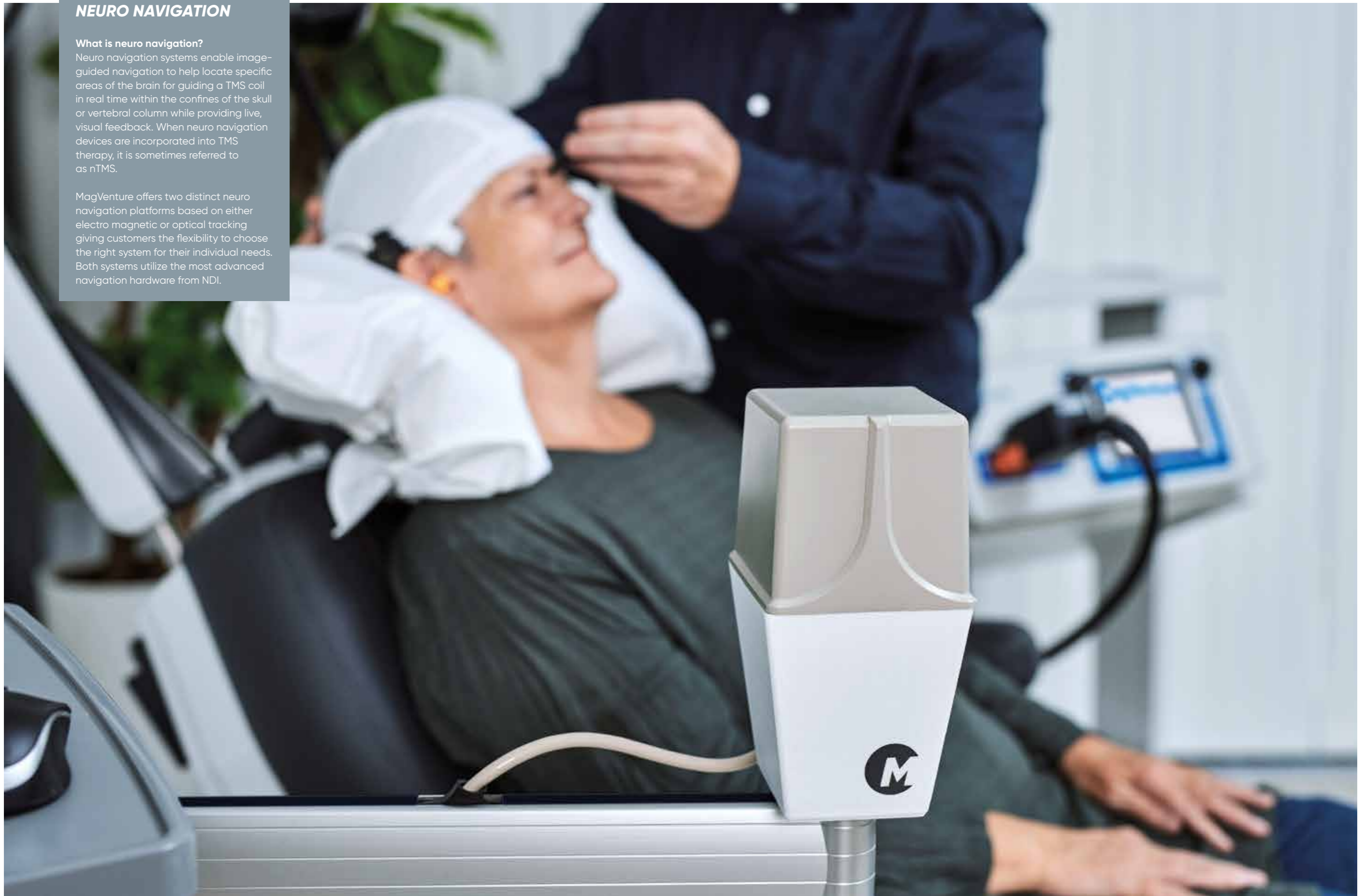

## Neuro navigation by electro magnetic tracking (MagVenture Atlas™)

Therapy



MagVenture Atlas™ Neuro Navigation System is an accurate coil positioning system for the clinical application of transcranial magnetic stimulation (TMS) using electro magnetic (EM) tracking from NDI.

MagVenture Atlas™ uses a MRI data set for accurate coil positioning – targeting the exact treatment spot and making it easy to consistently reposition the coil for repeat treatments.

- High precision and accuracy for clinical use
- Optimized workflow for clinical routine work incl. easy registration, calibration and sensor placement that reduces the manual method with tap and marker pens
- No line-of-sight issues and a lower price point compared to optical tracking
- Allows for personalized, consistent and easily repeatable coil positioning
- Can load and visualize individual MRI scans, tissue maps (e.g., gray matter), fMRI activation and craniotopic facial markers
- Integrates seamlessly with MagVentures' TMS therapy systems and subsequent treatment coils\* (\*Current MagVenture coils are C-B60, MCF-B65, Cool-B65, C-B70, MCF-B70, Cool-B70, Cool D-B80).
- Increased patient involvement increases confidence and trust
- Lightweight, compact and easy to set-up
- User-friendly interface

Part no.

9017M0011

EU Part no.

9018M0011



## Neuro navigation by optical tracking (Localite TMS Navigator TS)

Therapy

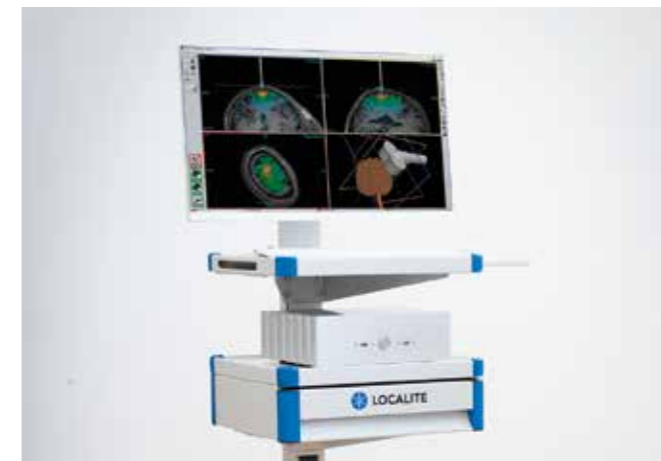

With TMS Navigator TS you can achieve the highest possible accuracy and maintain yourself the flexibility to personalize your TMS treatment to the uniqueness of your patient's brain.

Using individual MRIs is just as possible as falling back to a standard brain (MNI) that will be adapted to the patient. For target definition you are free to use either brain atlases, anatomical and even functional information.

- Highest precision with optical tracking
- Individualization by using either MRIs or individualized standard templates
- Versatile treatment planning by either using universal or personalized targets
- Integration with your MagVenture stimulator enables automatic documentation of your treatment protocol

## Robotic neuro navigation by optical tracking (Axilum Robotics)

Research



Axilum Robotics Cobot solution ensures movement control and a high level of repeatability and accuracy between TMS sessions. It is especially suited for research and works with MagVenture stimulators and coils. It can be piloted by a neuro navigation system from Localite (MRI guidance).

- High precision and accuracy for especially research use
- Maintains all parameters of TMS coil positioning (optical tracking)
- Compensates for potential head motion
- Maintains permanent contact between coil and head

## Neuro navigation by optical tracking (Localite)

Research



Localite's optical neuro navigation tracking makes it easy to plan stimulation areas, visualize the stimulation spot, and monitor and record the precise position of the research subject and coil with complete replicability. This turnkey solution provides full integration with MagVenture's product portfolio including advanced research coils, allowing for automatic and easy exchange of all required information such as intensity, coil and stimulator type, MEPs and temperature.

- Highest precision and accuracy – developed especially for research use
- Easily scalable with and without MRI
- Optical tracking of up to four coils simultaneously
- Works with more than 30 different MagVenture coils



*People  
around the world  
trust in our  
ongoing commitment  
to magnetic  
stimulation*







## ACCESSORIES

To customize and enhance your TMS system, we have a wide range of accessories. Many of our accessories, such as our trolleys, marking plates, mountings, and holders, have been designed to streamline your TMS process. Our coil cooling systems are designed to increase coil performance. Other accessories, such as the Super Flex Arm and Flow Arm have been developed to reduce stress and strain on the body of the operator, or to increase comfort for the person receiving TMS, as in the case with our adjustable treatment chair and vacuum pillow. All our accessories are designed to suit your specific situation and requirements, and always with functionality and aesthetics in mind.



### Trolley for MagPro X/R – Standard

A trolley specially designed to hold a complete TMS system with an R or X model MagPro stimulator, isolation transformer, coil cooler unit and vacuum pump unit. Complete with mounting for a flexible arm, sham noise generator and other accessories. The trolley comes in two sizes, a standard model and a high model (with an extra shelf). Suitable for MagPro R30, MagPro R30 with MagOption, MagPro X100 and MagPro X100 with MagOption.



Part no.	Weight	Dimensions
9016B0102	17 kg / 37.5 lbs	80 x 64 x 55 cm 31.5 x 25.2 x 21.65 in.

### Trolley for MagPro X/R – High

A trolley specially designed to hold a complete TMS system with an R or X model MagPro stimulator, isolation transformer, coil cooler unit and vacuum pump unit. Complete with mounting for a flexible arm, and holders for coils and other accessories. The high trolley comes with an extra shelf on the top for additional accessories. Suitable for MagPro R30, MagPro R30 with MagOption, MagPro X100 and MagPro X100 with MagOption.



Part no.	Weight	Dimensions
9016B0431	25 kg / 55 lbs	128 x 64 x 55 cm 50.39 x 25.2 x 21.65 in.

### Trolley for MagPro Compact and R20 Family

A trolley specially designed to hold a MagPro Compact or a MagPro R20 system with Isolation transformer and vacuum pump unit. Complete with mounting for a flexible arm and sham noise generator and other accessories.



Part no.	Weight	Dimensions
9016B0381	17 kg / 37.5 lbs	80 x 64 x 55 cm / 31.5 x 25.2 x 21.65 in.

### Additional shelf for MagPro X/R Trolley

Part no.
9016B3111



### Coil Extension Power Cable

To increase the cable length of a coil cable, 3 m and 5 m extension cables are available.

#### 3 meters

Part no.	Length
9016E4601	3 meters

#### 5 meters

Part no.	Length
9016E4611	5 meters

### Coil Lemo Extension Cable

Combination of a Coil Extension Power Cable (above in two different lengths) and a Coil Lemo Extension cable (with 4p or 6p connector)

#### Coil 4p

Part no.	Length
9016E4621	5 meters

#### Coil 6p

Part no.	Length
9016E4631	5 meters



## Coil Cooler for Cool Coils

A cooling system for MagVenture Cool coils. Equipped with special liquid cooling media.

Part no.	Weight	Dimensions
9016B0151	10 kg / 22 lbs	200 x 300 x 300 mm / 7.9 x 11.8 x 11.8 in.

<b>Mains Voltage</b>	230V~, 50/60Hz according to IEC 60601-1
<b>Max. Power Consumption</b>	40W
<b>Operation from</b>	100-120V~ through Transformer.
<b>MagVenture Isolation Transformers</b>	* 9016D0051: 100V~, 50/60Hz * 9016D0031: 120V~, 50/60Hz

9016H1001 + T1016101: Cooling liquid for cooler (2-3 pcs. is required to fill system completely) + Cooling Liquid Filler Tube (Male snap-connector mounted with 50 cm Ø6/8mm Tube for filling cooler)  
9016V0361: Thumb screws kit for Coil Cooler faceplate (4 pcs.)



## High-Performance Option for Coil Cooler

The High-Performance option for Coil Cooler is designed to increase cooling performance and allow for even more intensive protocols without the risk of overheating the coil.

Part no.	Weight	Dimensions
9016B0421	20 kg / 44 lbs	375 x 275 x 235 mm / 14.7 x 10.8 x 9.3 in.

<b>Mains Voltage</b>	230V~, 50/60Hz according to IEC 60601-1
<b>Max. Power Consumption</b>	300W
<b>Operation from</b>	100-120V~ through Transformer.
<b>MagVenture Isolation Transformers</b>	* 9016D0051: 100V~, 50/60Hz * 9016D0031: 120V~, 50/60Hz



## High-Performance Coil Cooling System

A package consisting of the Coil Cooler for Cool Coils and the High-Performance Option for Coil Cooler

Part no.	Weight	Dimensions
9016B0411	10 kg / 22 lbs + 20 kg / 44 lbs	200 x 300 x 300 mm / 7.9 x 11.8 x 11.8 in. + 375 x 275 x 235 mm / 14.7 x 10.8 x 9.3 in.

<b>Mains Voltage</b>	230V~, 50/60Hz according to IEC 60601-1
<b>Max. Power Consumption</b>	300W + 40W = 340W
<b>Operation from</b>	100-120V~ through Transformer.
<b>MagVenture Isolation Transformers</b>	* 9016D0051: 100V~, 50/60Hz * 9016D0031: 120V~, 50/60Hz



## Super Flex Arm for Coils

Developed for easy and flexible positioning of magnetic coils, the Super Flex Arm has three joints – two ball joints which rotate in multiple directions and a central joint which rotates in one direction. All three joints can be locked and unlocked by the grip on the central joint. The Super Flex Arm works with all types of coils. It comes in two lengths – the longer arm is recommended for mounting on a trolley and the shorter arm is recommended for mounting on the backrest of the Treatment Chair. Mounting kits are also available.



### Long

Part no.	Weight	Length – Vertical rod	Flexible rods	Coils
9016B0171	6.5 kg / 14.3 lbs	60 cm / 23.6 in.	2 x 40 cm / 2 x 15.7 in.	All coils up to ø38 mm (1.5 in.) handle

### Short

9016B0181	6 kg / 13.2 lbs	60 cm / 23.6 in.	2 x 25 cm / 2 x 9.8 in.	All coils up to ø38 mm (1.5 in.) handle
-----------	-----------------	------------------	-------------------------	---

## Flow Arm

MagVenture's patented Flow Arm is especially designed to support easy placement of the TMS coil, reducing effort and strain on the operator, making it ideal for multiple sessions in a day. It has been developed for clinical practice to optimize workflow, while maintaining accuracy and flexibility. The Flow Arm makes it easy to securely position the treatment coil and fits all treatment coils. Please note: Flow Arm only works with treatment chairs purchased after Q1 2017 (> sn1307 and all new orders for treatment chairs can carry the Flow Arm without modification)



Part no.	Height	Length	Weight	Supported coil weight
9016B0801	550 mm / 21.7 in.	450 mm / 17.7 in.	10 kg / 22 lbs excl counterweight 20 kg / 44 lbs incl counterweight	1.5-3 kg / 3.3-6.6 lbs

### Flow Arm and Treatment Chair bundle package

Includes: 9016B0801 and 9016B0082.

Part no.
9016B0851

### Flow Arm coil clamps ø29 – 2 pcs.

Two extra coil clamps for the Flow Arm, with diameter of 29 mm.

Part no.
9016B0841

### Flow Arm coil clamps ø38 – 2 pcs.

Two extra coil clamps for the Flow Arm, with diameter of 38 mm.

Part no.
9016B0811

### Flow Arm coil clamp A/P kit ø38 – 1 pcs.

An extra coil clamp for the Flow Arm, with diameter of 38 mm.

Part no.
9016B0861



### Treatment chair with neckrest – Newly improved

The newly improved Treatment Chair has been developed for use with the MagVenture TMS Therapy System®. The special neck rest is designed with a wide range of adjustment options for greatest possible comfort for the patient. The chair has adjustable height, seat angle, footrest, and backrest, operated by remote control. The Treatment Chair can be mounted with the Super Flex Arm or the Flow Arm for easy and secure placement of the different treatment coils.

Please note: Flow Arm only works with treatment chairs purchased after Q1 2017 (> sn1307 and all new orders for treatment chairs can carry the Flow Arm without modification).

Mandatory to power the Treatment Chair via the MagVenture Isolation Transformer from 100-120-230V (see page 14).



Part no.	Color
9016B0081	Grey (anthracite) PVC upholstery
<b>Width</b>	63 cm / 24.8 in., without armrest 80 cm / 31.5 in., with armrest
<b>Height</b>	63-87 cm (24.8 - 34.3 in.)
<b>Length</b>	190 - 210 cm (74.8 - 82.7 in.)
<b>Weight</b>	85 kg / 187 lbs
<b>Patient max. weight</b>	150 kg / 330 lbs
<b>Safe working load</b>	235 kg / 517 lbs
<b>Mains Voltage</b>	230V~, 50/60Hz
<b>Max. Power Consumption</b>	50VA

9016V0331: Treatment Chair wheels (4 pcs.) for transportation/moving

### Treatment Chair foot rest plastic cover

An additional plastic cover for the footrest of the Treatment Chair.



Part no.
9016B0451

### Treatment Chair terry cover

An additional terry cloth cover for MagVenture's Treatment Chair.



Part no.
9016B0461

### Vacuum Pump Unit

A vacuum pump for evacuating air from a vacuum pillow to support the patient's head during TMS. When air is evacuated, the pillow becomes stable in the chosen form and firmness. When the air valve is released, allowing air into the pillow, the vacuum pillow regains its flexibility and is ready to be shaped again. It is easily controlled by a foot switch.

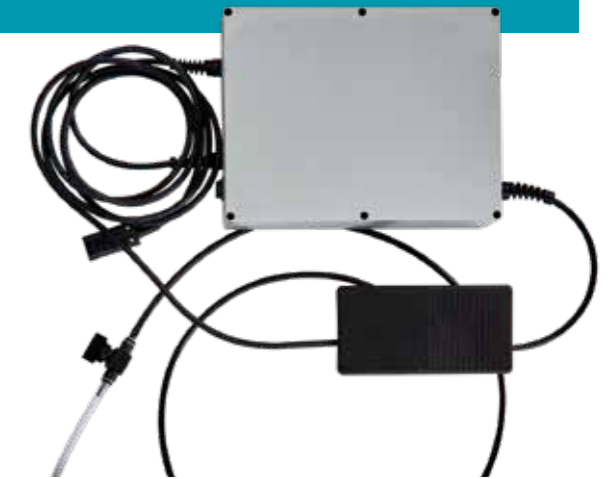

Part no.	Dimensions
9016B0121	12 x 30 x 23 cm

**Mains Voltage** 230V~, 50/60Hz

**Max. Power Consumption** 35VA

### Vacuum Pillow 70 cm

The vacuum pillow is used around the patient's head or neck, the air is evacuated from the pillow with a foot-controlled vacuum pump so that it becomes firm.



Part no.	Dimensions
9016B0132	70 x 30 x 5 cm / 27.6 x 11.8 x 2 in.

### Pillowcase 70 cm

Additional cotton pillowcases (pack of 5) to fit MagVenture's vacuum pillow. 100% cotton, washable at 60°C (140°F).



Part no.	For existing customers with the old 55 cm vacuum pillow, additional cotton pillowcases (pack of 5) can still be ordered using part no. 9016B0261.
9016B0671	



### Universal Coil & Connector Holder for Trolley/Wall

When performing research or depression treatment with TMS, more than one coil is often used during the process.

The accessories kit, designed for easy placement of coils on the trolley, includes:

- Holder for a variety of coils incl. cool coils
- Holder for coil connector of TMS coil during motor threshold determination

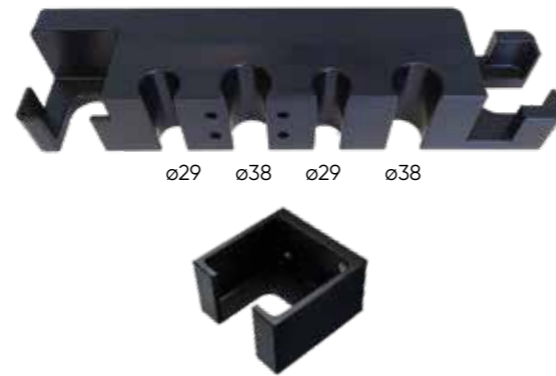

Part no.
9016B0581
9016B0281

### Dual Slot Coil & Connector Holder for Trolley/Wall

When performing research or depression treatment with TMS, more than one coil is often used during the process.

The accessories kit, designed for easy placement of coils on the trolley, includes:

- Holder for an extra standard coil, (e.g. C-B60 for motor threshold determination)
- Holder for TMS coil connector during motor threshold determination

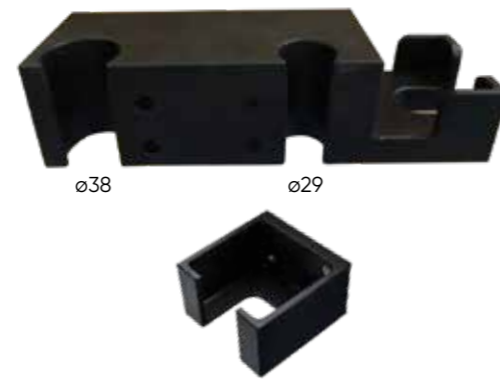

Part no.
9016B0441
9016B0281

### Wall Mount Bracket for Super Flex Arm

A bracket for attaching the Super Flex Arm to a wall.

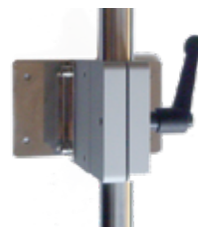

Part no.
9016B0371

### Table Mount Bracket for Super Flex Arm

A bracket for attaching the Super Flex Arm to a table.



Part no.
9016B0391

### Additional Aluminum Mounting Bracket with Lever for MagPro Super Flex Arm

Additional Flex Arm mounting bracket Trolley/Chair.



Part no.
9016B0177

### Dual Slot Coil Holder for Trolley/Wall (1 x ø29 coil + 1 x ø38 coil)

A holder for all MCF- and Cool-coils (besides MCF-75) and for standard coils with ø29 mm handle, attaching to a trolley or wall.



Part no.
9016B0351

### Universal Coil Holder for Trolley/Wall (2 x ø29 coils + 2 x ø38 coils)

A holder for all MCF- and Cool-coils (besides MCF-75) and for standard coils with ø29 mm handle, attaching to a trolley or wall.



Part no.
9016B0361

### Accessories for Trolley (coil connector holder)

Holder for an extra standard coil, designed for easy placement of coil on the trolley.

Part no.
9016B0281

## HANDLE DIAMETERS OF MAGVENTURE COILS

Diameter of handle (øD in mm)	Diameter of handle ø25	Diameter of handle ø29	Diameter of handle ø38
Coil type	Coil type	Coil type	Coil type
MC-B35	C-100	MCF-B70	
MC-B65-HO	C-B60	MCF-P-B70	
RT-120	C-B70	Cool-B35	
RT-120-II	MC-B70	Cool-B35 RO	
MCF-75	MC-P-B70	Cool-B35 HO	
	MC-125	Cool-B65	
	D-B80	Cool-B65 RO	
	D-B110	Cool-B65 CO	
	MMC-90	Cool-B65 A/P	
	MMC-140	Cool-B65 A/P RO	
	MMC-140-II	Cool-B65 A/P CO	
	MMC-140 A/P	Cool-B70	
	MCF-B65	Cool-B70 CO	
	MCF-P-B65	Cool-B70 A/P	
	MCF-125	Cool-D50	
	MCF-140	Cool D-B80	
		Cool D-B80 A/P	
		Cool-125	





## GENERAL INTRODUCTION TO MARKING PLATES

MagVenture has a wide range of marking plates for basic neuro navigation for both approved indications and research studies. The marking plates may vary according to method used.



## Marking Plate and Accessories Kit

Compatible with	Left Orientation	Part no.	Right Orientation	Part no.	Marking plate
<b>Coil C-B70</b>	Left 5.5 cm	9016B0681	Right 5.5cm	9016B0691	
<b>Coil Cool-B70 and Coil MCF-B70</b>	BeamF3 Left 5 cm - hand held	9016B0751			
	BeamF3 Left 5.5 cm - hand held	9016B0761			
	Left 5.5 cm <SN3000	9016B0641	Right 5.5 cm <SN3000	9016B0631	
	Left 5.5 cm >SN3000 (new)	9016B0642	Right 5.5 cm >SN3000 (new)	9016B0632	
<b>Coil C-B60</b>	Left 5 cm	9016B0191	Right 5 cm	9016B0521	
	Left 5.5 cm	9016B0501	Right 5.5 cm	9016B0531	
	Left 6 cm	9016B0511	Right 6 cm	9016B0541	
	Adjustable	9016B0561	Adjustable	9016B0561	
<b>Coil Cool-B65 and Coil MCF-B65</b>	Left 5 cm	9016B0551			
	Left 5.5 cm	9016B0571			
	Left 5.5 cm - hand held	9016B0821	Right 5.5 cm - hand held	9016B0	
<b>Coil Cool D-B80</b>	Left 5.5 cm	9016B0781			

## Treatment accessories kit

An accessories kit for depression treatment with theta burst.

The kit includes: adhesive clips, textile pen, ear plugs, ruler, measuring tape, USB memory key, holder for trolley, labels for Cool D-B80 coil.

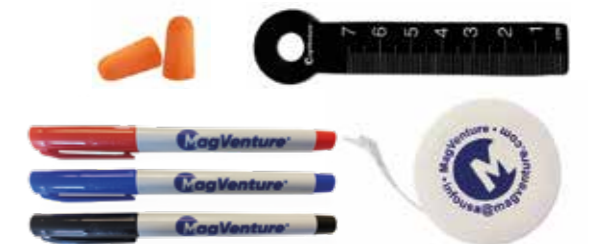

Part no.
9016B0331



**Your work environment, our concern**

We develop solutions that relieve the burden from operators doing repetitive work every day.

**Textile Cap**

A textile cap with a measurement pin for depression treatment when determining motor threshold, making it easy to mark and position the treatment coil. The patient ID and distance to the edge can be written on the cap, making it re-usable for that patient – one cap per patient. Optional chin straps are available.



**Chin Strap - 10 pcs.**

Part no.
9016B0651

**Extra Small - 10 pcs.**

Part no.
9016B0591

**Small - 10 pcs.**

Part no.
9016B0201

**Medium - 10 pcs.**

Part no.
9016B0211

**Large - 10 pcs.**

Part no.
9016B0221

**Extra Large - 10 pcs.**

Part no.
9016B0231

**Bundle - 10 pcs. of XS-S-M-L-XL**

Part no.
9016B0601





## POPULAR TMS PACKAGES

We know that it can be difficult to maneuver among the many products and possibilities within the TMS world. Therefore, we've compiled five of our most commonly purchased configurations for TMS systems and created four convenient packages for your inspiration.

The **Diagnostics Package** is designed for performing a lower number of sessions per day.

The **Therapy Package** is designed for small-scale practices, suited for performing a lower number of TMS sessions per day, with less intensive protocols.

The **High Performance Therapy Package** is designed for performing multiple, successive TMS sessions in a day, for more intensive protocols with a higher number of stimuli.

The **Research Package** offers the possibility for a wide range of protocols, including single and double blind studies, animal research and use with MRI scanners.

The **mPNS Package** provides brief and focused magnetic pulses to non-invasively stimulate peripheral nerves and provide relief of chronic intractable, post-traumatic and post-surgical pain.

The TMS packages on the following pages serve only as inspiration. As with all our products, they can be customized and enhanced to suit your specific situation and requirements.



### Diagnostics Package with MagPro Compact

Category	Part no.	Name
Stimulator	9016E0852	MagPro Compact
Coils	9016E0582	Coil C-100
Accessories	9016B0381	Trolley for MagPro Compact and R20
	9016E4561	Triggercable - BNC

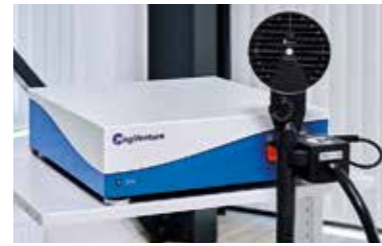

### Therapy Package with MagPro R20 Family

Category	Part no.	Name
Stimulator	9016E0911	MagPro R20+ Express incl. WiFi Option
	9016D00X1	Isolation Transformer MagPro R & X Models
Coils	9016E0401	Coil MCF-B70
Accessories	9016B0381	Trolley for MagPro Compact & R20
	9016B0171	Super Flex Arm for Coils (short)
	9016B0081	Treatment Chair with neckrest
	9016B0121	Vacuum Pump Unit
	9016B0132	Vacuum Pillow 70 cm
	9016B0671	Pillowcase 70 cm (pack of 5 pcs.)
	9016B0641	Marking acc. f/MCF-B70 Click-On, 5.5cm
	9016B0441	Acc. for MagPro R20 Trolley (Depression)
9016B0601	Textile Cap, Bundle 10 pcs of XS-S-M-L-XL	



### Therapy Package with MagPro R30

Category	Part no.	Name
Stimulator	9016E0721	MagPro R30
	9016D00X1	Isolation Transformer MagPro R & X Models
Coils	9016E0491	Coil Cool-B65
	9016E0482	Coil C-B60
Accessories	9016B0151	Coil Cooler for Cool Coils
	9016B0081	Treatment Chair with neckrest
	9016B0181	Super Flex Arm for Coils (short)
	9016B0102	Trolley for MagPro X/R
	9016B0191	Marking acc. for Depression studies, Left 5cm
	9016B0121	Vacuum Pump Unit
	9016B0132	Vacuum Pillow 70 cm
Extras	9016B0671	Pillowcase 70 cm (pack of 5 pcs.)
	9016B0601	Textile Cap, Bundle 10 pcs of XS-S-M-L-XL
9016E0361	Theta Burst Option for MagPro R30	



### mPNS Package

Category	Part no.	Name
Stimulator	9016E0721	MagPro R30
	9016D00X1	Isolation Transformer MagPro R & X Models
Coils	9016E0631	MMC-140-II
	9016E0651	RT-120-II
	9016E0211	MMC-90
	9016E0413	MCF-125
	9016E0491	Cool-B65
	9016E0511	Cool-125
Accessories	9016B0151	Coil Cooler for Cool Coils
	9016B0431	Trolley for MagPro X/R
	9016B0181	Super Flex arm for Coils (short)





## High Performance Therapy Package with MagPro R30

Category	Part no.	Name
Stimulator	9016E0721	MagPro R30
	9016D00X1	Isolation Transformer MagPro R & X Models
Coils	9016E0141	Coil C-B70
	9016E0521	Coil Cool-B70
	9016E0531	Coil Cool D-B80
Accessories	9016B0151	Coil Cooler for Cool Coils
	9016B0081	Treatment Chair with neckrest
	9016B0801	Flow Arm incl. 2 x Clamp kit, ø38
	9016B0431	Trolley for MagPro X/R – High
	9016B0281	Accessories for Trolley
	9016B0361	Universal Holder for Coils Ø25-Ø38, cart/wall mount
	9016B0681	Marking acc. for Depr. (C-B70 Clips on) Left 5.5cm
	9016C0901	360 Gateway Unit (computer f./internet access)
	9016C0911	360 Monitor (touch screen f./computer)
	9016B0701	360 Mounting Kit (arm and bracket)
	9016P0201	360 Software License
	9016B0121	Vacuum Pump Unit
	9016B0132	Vacuum Pillow 70 cm
	9016B0671	Pillowcase 70 cm (pack of 5 pcs.)
	9016B0601	Textile Cap, Bundle 10 pcs of XS-S-M-L-XL
Extras	9016E0361	Theta Burst Option for MagPro R30



Add-ons	9016C0701	MEP Monitor (incl. 1.5mm cable and electrodes)
	9016E0381	80pps Option for MagPro R30
	9016V0201	Noise Filters for optimized EEG usage
	9016E0511	Coil Cool-125
	9016B3111	Additional Shelf for MagPro Cart

## Clinical Research Package with MagPro X100 with MagOption

Category	Part no.	Name
Stimulator	9016E0731	MagPro X100 incl. MagOption
	9016D00X1	Isolation Transformer MagPro R & X Models
Coils	9016E0141	Coil C-B70
	9016E0521	Coil Cool-B70
	9016E0121	Coil Cool-B70 A/P
	9016E0541	Coil Cool D-B80 A/P
Accessories	9016S0161	Double Blinded Research Studies for MagPro
	9016B0151	Coil Cooler for Cool Coils
	9016B0081	Treatment Chair with neckrest
	9016B0801	Flow Arm incl. 2 x Clamp kit, ø38
	9016B0861	Flow Arm coil clamp A/P kit ø38 – 1 pcs.
	9016B0102	Trolley for MagPro X/R
	9016B0361	Universal Holder f Coils Ø25-Ø38, cart/wall mount
	9016E4561	Cable Ext. Trig with BNC
	9016B0121	Vacuum Pump Unit
	9016B0132	Vacuum Pillow 70 cm
9016B0671	Pillowcase 70 cm (pack of 5 pcs.)	
9016B0601	Textile Cap, Bundle 10 pcs of XS-S-M-L-XL	



Add-ons	9016B0421	High-Performance Option for Coil Cooler
	9016C0701	MEP Monitor (incl. 1.5mm cable and electrodes)
	9016E0341	250pps Option for MagPro X100
	9016B0681	Marking acc. for Depr. (C-B70 Clips on) Left 5.5cm
	9016V0201	Noise Filters for optimized EEG usage
	9016B3111	Additional Shelf for MagPro Cart



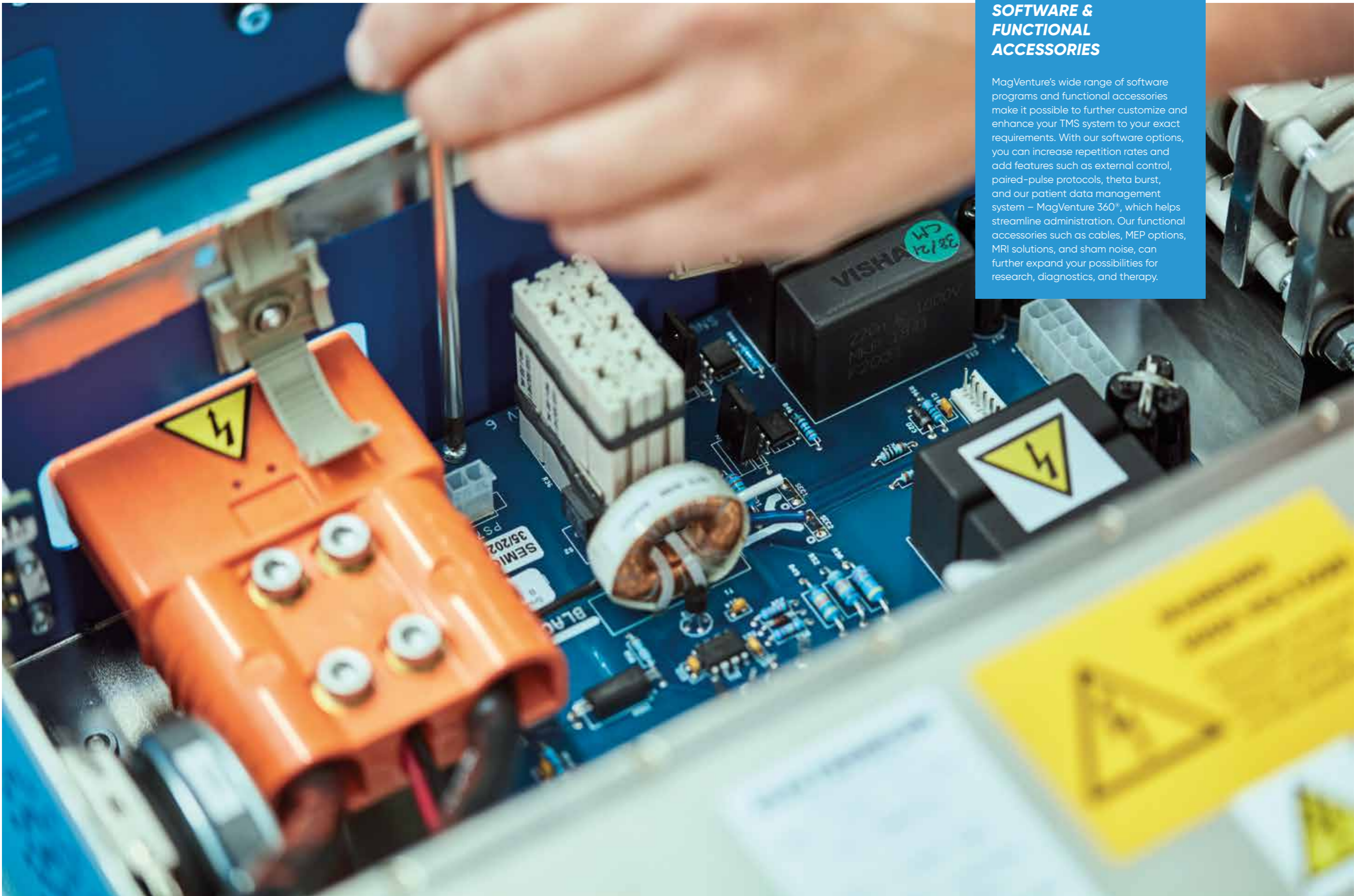

## SOFTWARE & FUNCTIONAL ACCESSORIES

MagVenture's wide range of software programs and functional accessories make it possible to further customize and enhance your TMS system to your exact requirements. With our software options, you can increase repetition rates and add features such as external control, paired-pulse protocols, theta burst, and our patient data management system – MagVenture 360®, which helps streamline administration. Our functional accessories such as cables, MEP options, MRI solutions, and sham noise, can further expand your possibilities for research, diagnostics, and therapy.



### External Control Software

#### External Control Software for MagPro X/R

This software makes it possible to externally control a MagPro simulator and receive log information when a MagPro stimulator is placed in an equipment room behind the MRI-scanner room and away from the operator room. Only for the R30 and X100 stimulators.

Part no.

9016S0141

### MagPro R30, 60 pps option

A specialized software version that increases the repetition rate for a MagPro R30 from 30 Hz to 60 Hz.

Part no.

9016E0321

### MagPro R30, 60 pps and Theta Burst option

A specialized software version that increases the repetition rate for a MagPro R30 from 30 Hz to 60 Hz and at the same time makes it possible for the MagPro R30 to stimulate theta burst protocols.

Part no.

9016E1101

### MagPro R30, Theta Burst option

A specialized software that makes it possible for the MagPro R30 to stimulate theta burst protocols.

Part no.

9016E0361

### R20 family wifi option for reporting and protocol set-up

#### WiFi Dongle, Acces Point, Software

A Wi-Fi package containing a secure Wi-Fi connection and software for running the MagPro R20 Configurator including reporting functionality. The MagPro R20 Configurator is used to easily create protocols on your computer to upload to the MagPro R20 and subsequently print log files of performed protocols with your own logo.

Part no.

9016C0821

### Paired-Pulse Composer

#### Control software for stim. w. MagOption

A software program for creating, saving, and executing randomized paired-pulse protocols for research studies. For reliability, the actual realized outcome for each pulse pair is measured by the MagPro stimulator and displayed in the Paired-Pulse Composer. Only supported by the MagPro R30+Option and MagPro X100+Option with software 7.1. or newer.

Part no.

9016S0171

### MagPro R30, 80 pps option

A specialized software that increases the repetition rate for a MagPro R30 from 30 Hz to 80 Hz.

Part no.

9016E0381

### MagPro R30, 80 pps and Theta Burst option

A specialized software version that increases the repetition rate for a MagPro R30 from 30 Hz to 80 Hz and at the same time makes it possible for the MagPro R30 to stimulate theta burst protocols.

Part no.

9016E1111

### MagPro X100, 250 pps option

A specialized software that increases the repetition rate for a MagPro X100 or X100+MO from 100 Hz to 250 Hz.

Part no.

9016E0341



### MagVenture 360® Patient Data Management System

The MagVenture 360® patient data management system is a cloud-based, GDPR compliant system for use in clinical settings, providing secure data storage. With the 360 software added to your MagVenture TMS Therapy system you have anytime, anywhere access from devices such as laptops and tablets. It reduces administration time by storing all patient data in one place.

Part no.

9016S0191

#### 360 Mounting kit for Monitor

A bracket for the 360 monitor, so it can be mounted on the side of a trolley.

Part no.

9016B0701

#### 360 Monitor

A touch screen monitor for use with the MagVenture 360 solution. Includes an arm that can be mounted on a trolley.

Part no.

9016C0911



The solution package consists of a 360 gateway unit with native application, a touch screen monitor with data from the 360 web application, access to the 360 web application (from any device) and an annual software license. Compatible with R30 or X100. One license can be used for multiple devices within the same company.

#### 360 Gateway unit

The MagVenture 360 gateway unit is for placement on the back of the stimulator (R30 or X100).

Part no.

9016C0901



### MEP Monitor

A one channel EMG amplifier for mounting on the back of the MagPro R/X systems (not compatible with R20 or Compact). For measurement of motor evoked potential (MEP). Especially designed for determination of motor threshold.



#### MEP Monitor (incl. 0.7 mm cable and electrodes)

Part no.
9016C0701

#### MEP Monitor (incl. 1.5 mm cable and electrodes)

Part no.
9016C0711

### MEP Monitor Electrode Cables

A shielded electrode cable for MEP monitor for active, reference and ground electrodes.



#### 1.5 mm connector for MEP

Part no.
9016C0811



#### 0.7 mm connector for MEP

Part no.
9016C0851

### Surface Electrodes - 12 pcs.



#### 1.5 mm Surface Electrodes

Used for MEP recordings as active, reference and ground electrode and used for A/P coils for current stimulation.

Part no.
9016S0201



#### 0.7 mm Surface Electrodes

Used for MEP recordings as active, reference and ground electrode

Part no.
9016S0211

### Coil Converter, MagPro Compact

An external power control for coils without controls on the coil handle. For use with the MagPro Compact, the interface unit is mounted on the front of the device between the stimulator and the coil. Can be used for all coils except C-100, C-B60, C-B70, RT-120-II and MMC-140-II. Note: MCF and Cool coils are not supported.

The coil converter must always be used together with a coil interface 6p to 4p LEMO (part no. 9016E4671).



Part no.	+	Part no.
9016B0102		9016E4671

### Coil Interface Cable 4p to 6p LEMO

A LEMO coil interface cable for use with MagPro and MagPro R20 only. To minimize the mechanical stress on the small 4p LEMO connector on coils, when disconnecting and reconnecting the coil to the MagPro, an interface cable with the more robust 6p LEMO connector can be a solution. For connections of supported coils with 4p LEMO connector to MagPro R20.



Part no.
9016E4641

### Foot Switch for MagPro R30/X100

A foot switch for external triggering of MagPro R30 or X100. The foot switch is connected to the trigger connector on the rear panel and generates an external trigger signal to control start and stop of stimulation sequences with a timing setup.



Part no.
9016C0791

### Foot Switch for MagPro R100

A foot switch for external triggering of MagPro R100. The foot switch is connected to a COM2 serial port and generates an external trigger signal to control start and stop of stimulation sequences with a timing setup.



Part no.
9016C0831



### External Trigger Cable (9p D-Sub)

A cable for external triggering to/from an external device using a 9p D-sub connector (e.g. Keypoint EMG/EP system).



Part no.	Connectors	Cable length
9016E4551	9p D-sub plug (MagPro) 9p D-sub plug (Keypoint)	3 m

### External Trigger Cable (BNC)

A cable for external triggering to/from an external device using BNC connectors.



Part no.	Connectors	Cable length
9016E4561	9p D-sub plug (MagPro) 2 x BNC plug	3 m

### MagPro-MagPro Trigger Cable

A cable for external triggering from one MagPro stimulator to another, making it possible to have two magnetic coils connected and synchronized.



Part no.	Connectors	Cable length
9016E4571	9p D-sub plug (MagPro master) 9p D-sub plug (MagPro slave)	2 m

### External Trigger Cable Splitter (9p D-Sub)

A cable splitter for external triggering of a MagPro slave device as well as an external device (e.g. Keypoint EMG/EP system).



Part no.	Connectors
9016E4581	9p D-sub plug (MagPro master) 9p D-sub plug (MagPro slave) 9p D-sub plug (Keypoint)

### MagProbe (DIN connector)

MagProbe is a simple tool that provides information about the magnetic field from stimulating coils. Designed to estimate the suitability of a coil for a specific application. Making it possible to predict the coil's ability to stimulate at different locations in tissue, when using different coil positions. Probe loop area is 314 mm<sup>2</sup> as the type with BNC connector.



Part no.	Connector	Cable length	Loop wire	Loop inner diameter	Output voltage	Accuracy
9016E0311	5p DIN plug	3 m	ø2.8 mm CU.	20 mm	1 V per 1 kT/s.	± 10 %

### MagProbe (BNC connector)

MagProbe is a simple tool that provides information about the magnetic field from stimulating coils. Designed to estimate the suitability of a coil for a specific application. Making it possible to predict the coil's ability to stimulate at different locations in tissue, when using different coil positions.



Part no.	Probe loop area	Cable length	Wire diam	Loop inner diameter	Output voltage	Accuracy
9016E0331	314 mm <sup>2</sup>	> 3 m	ø2.8 mm.	20 mm	1 V per 2.6 kT/s.	± 10 %

### MagProbe 3D (BNC connector)

A probe for the measurement of a coil's magnetic field in 3D.



Part no.	Connector BNC plug	Cable length	Loop wire	Loop inside diameter	Output voltage	Accuracy
9016E0351	3 pcs.	2 m	ø0.2mm CU.	ø10 – 10 windings	1 V per 1.4 kT/s	±5%

### Current Stimulation Cable for A/P Coils

A spare part for current stimulation output and for electrodes with 1.5 mm connectors.



Part no.
9016C0801

### 7-channel MR coil array for concurrent TMS/fMRI

A radio frequency coil for magnetic resonance investigations of the human brain in vivo. Intended for use with a type 3T MRI Scanner and in combination with MRI-B91 or MRI-B91 Air Cooled coils.

For two MR coil arrays use two TIM adapters (order at Siemens)



Part no.	Type
9016M0021	fMRI A-type
9016M0041	fMRI B-type (for imaging only)

### Power Line filter for MRI

A power line filter for all cables entering the MRI room to support obtaining proper MRI images (without filtering MRI images may be impaired).



Part no.
9016C0751

### Double Power Line Filter for MRI

Intended for MRI installations where two scanners are located close to each other. The double filter ensures that crosstalk from one scanner room is not transported through the MRI coil installation to the other scanner room. The double power line filter is designed with one filter box inside the scanner room and with one filter box outside the scanner room to filtering signals in both directions.

Part no.
9016C0731

### Remote Control for MRI

A remote control for operating a MagPro stimulator at a distance. The remote control can enable MagPro, activate single stimuli and set the output power from a distance. The LED indicates whether the stimulator is enabled or disabled.



Part no.
9016C0721

### Emergency Stop for MRI

A emergency stop device for a patient to have with them inside the scanner. The patient can disable the MagPro stimulator at any time.



Part no.
9016C0741

### MagPro Upgrade for Emergency Stop

An emergency stop device that allows the patient or operator to disable the MagPro stimulator from a distance. For supporting connection of the emergency stop device to the front panel of the stimulator, an upgrade to the MagPro device must be ordered.

Part no.
9016C0841

### Leakage Current

#### MagPro Standard Leakage Current Reduction for MRI

Minimum requirements for all MagPro stimulators to be used in MRI environment along with the MRI-B91 coils.

Part no.
9016E1042

#### MagPro Dynamic and Standard Leakage Current Reduction for MRI

A filter unit added to the MagPro stimulator to eliminate/reduce artefacts during charging of the capacitor inside the stimulator, allowing MRI when recording very close to stimulation. The DC-leakage component when not charging has been reduced to below 1uA with this option.

Part no.
9016E1052

#### MagPro XP Leakage Current Reduction for MRI

A filter unit added to the MagPro stimulator to eliminate/reduce artefacts during charging of the capacitor inside the stimulator, allowing MRI when recording very close to stimulation. The DC-leakage component when not charging has been reduced to below 1uA with this option.

Part no.
9016E1071





### MRI-Coil Holder (for Siemens Magnetom Trio scanner)

A holding device used for MRI coil placement inside an MRI scanner. For easy, stable, and precise positioning of the MRI coil. 6 degrees of freedom (X, Z and 4 angular adjustments) with scales. One-grip fine tuning to ensure coil is placed perpendicular to the scalp.

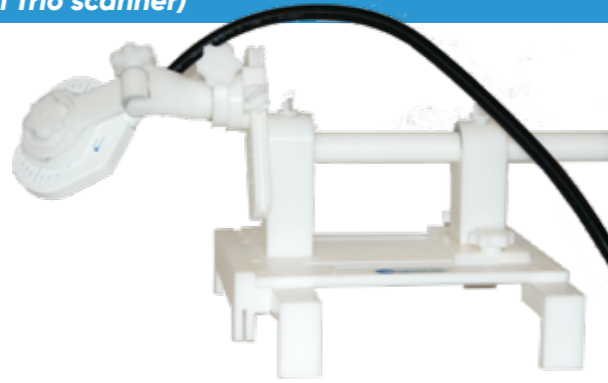

Part no.

9016B0401

### MRI-Coil Holder (for Siemens Magnetom Prisma and Skyra scanner)

A holding device used for MRI coil placement inside an MRI scanner. For easy, stable, and precise positioning of the MRI coil. 6 degrees of freedom (X, Z and 4 angular adjustments) with scales. One-grip fine tuning to ensure coil is placed perpendicular to the scalp.

Part no.

9016B0471

### Additional Front part

An extra coil holder for a second 7-channels RF pick-up coil.

Part no.

9016B0481

### EEG Noise Filter

#### MagPro R20 and MagPro Compact

An upgrade to the MagPro device to optimize it for EEG measurements.

Part no.

9016V0211

#### MagPro R30 and X100

An upgrade to the MagPro device to optimize it for EEG measurements

Part no.

9016V0201



### TMS Sham Noise Generator

For use in single and double blind studies, the device generates white noise or "sham noise" to hide the click sound of magnetic stimulation pulses and mask the lack of stimulation with a sham coil. This sham noise pulse will hide click noises from the coil even at 100% stimuli intensity. Two headsets are included with Sham Noise Generator (one for the patient and one for the operator – for double blind research). Each headset has a 2 m extension cables. Additional headsets and earplugs are available.



Part no.

9016C0772

### Additional Headset for Sham Noise

Part no.

9016C0782

### Earplug for Sham Noise Headset (5 sets)

Part no.

9016B0271

### Neuro 3D Vibration Tool

A handheld vibration tool that helps relieve pain and tension through loosening the adhesions of tendons, ligaments, and fascia. The Neuro 3D vibration tool serves as an excellent add-on to functional magnetic stimulation.



Part no.

9016M0011

### Neuro 3D Vibration Tool – Versatile Module

A versatile module with 8 vibration heads, allowing for different types of vibration: focused, broad, intense, and shallow, of connective tissue. Types of heads: chisels (two sizes), round (three sizes), pointed, and vertebra (two sizes).



Part no.

9016M0031



**Quality  
you can trust**

All our stimulators and coils are designed, developed and quality tested in Denmark.







## ***THIS IS MAGVENTURE***

MagVenture is a market-leading manufacturer of non-invasive Transcranial Magnetic Stimulation (TMS) and Magnetic Peripheral Nerve Stimulation (mPNS) systems. Privately-owned and headquartered in Denmark, MagVenture has been pioneering cutting-edge magnetic stimulation solutions for more than 30 years. MagVenture's TMS and mPNS systems are used for a wide range of applications in both research and treatment in the fields of psychiatry, neurophysiology, neurology, cognitive neuroscience, and rehabilitation.

MagVenture's vision is to offer new hope to patients by transforming how mental health and physical conditions are treated.

Our mission is to pioneer safe, effective, and reliable magnetic stimulation therapies, offer innovative and versatile research solutions and work to expand access to magnetic stimulation worldwide.

MagVenture's products are available on the global market through direct sales subsidiaries in the USA, Germany, the UK, China, and Brazil, and through a global network of distributors.

***Read more about us and get in contact at  
[www.magventure.com](http://www.magventure.com)***